

EJERCICIOS DE PERSPECTIVA ISOMÉTRICA

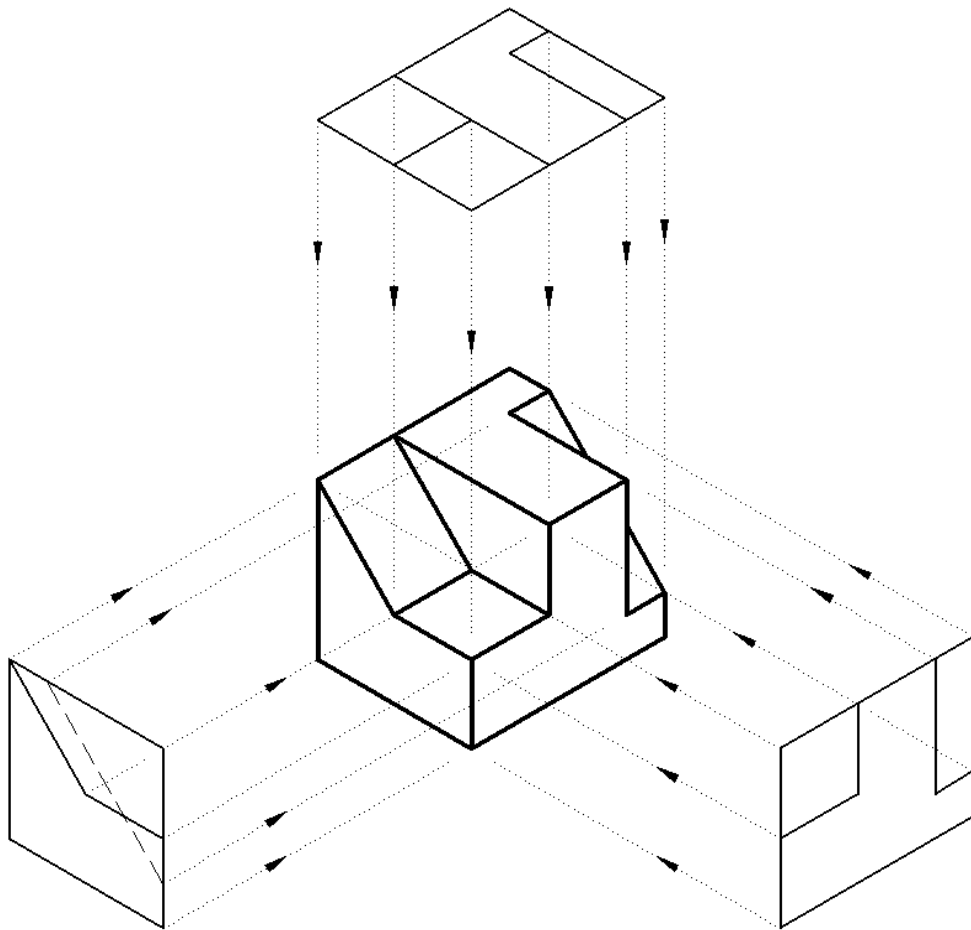

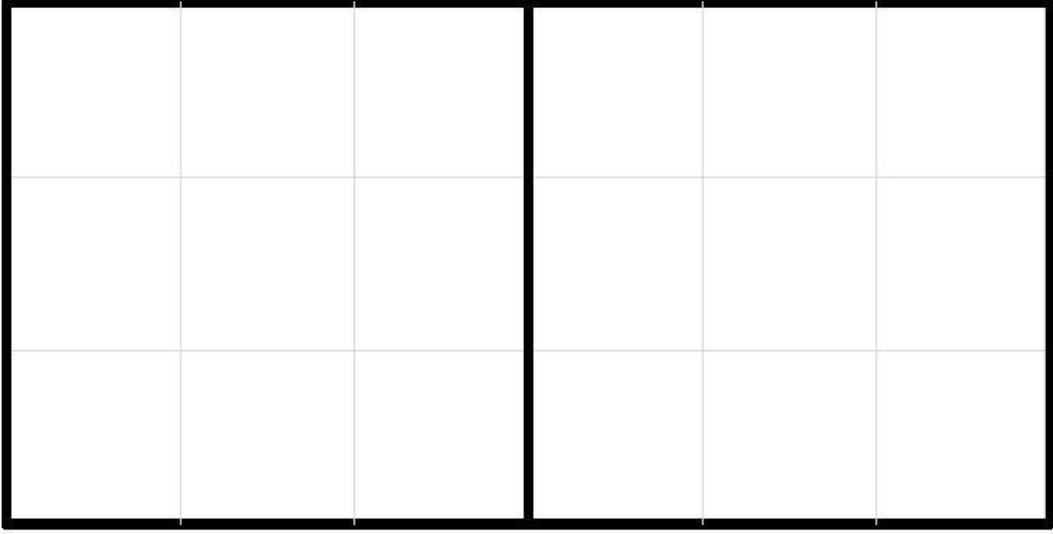

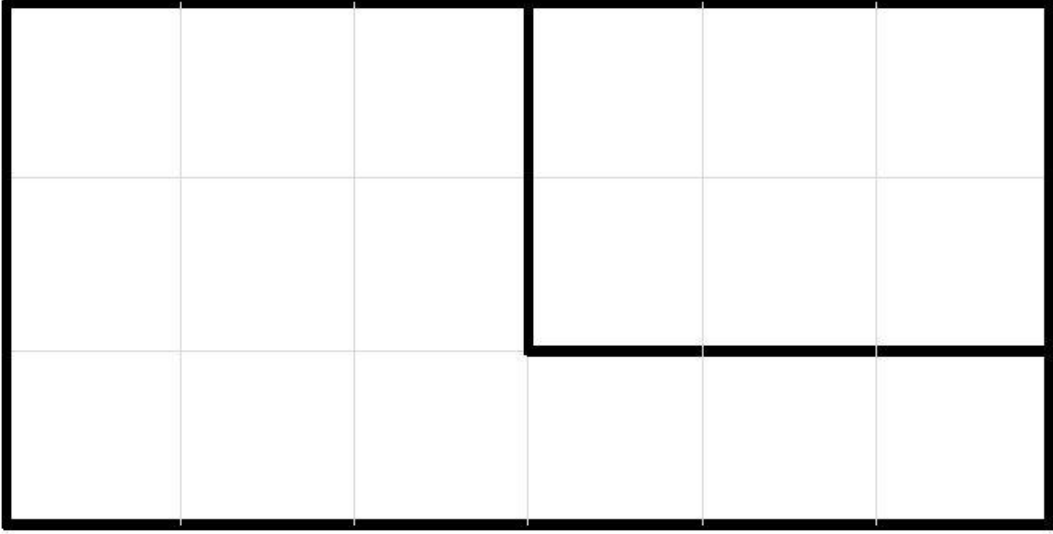

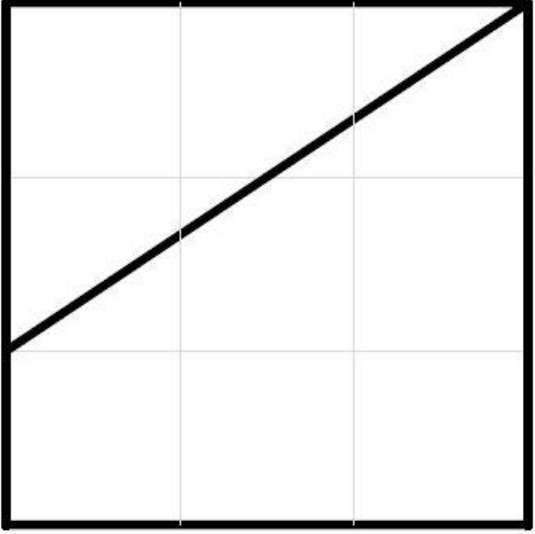
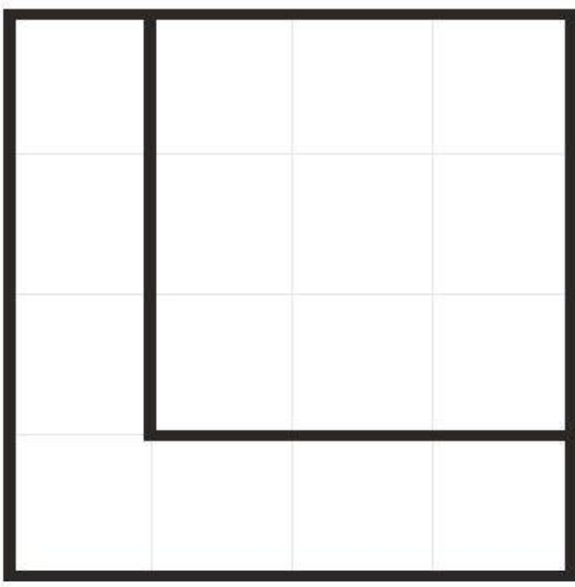
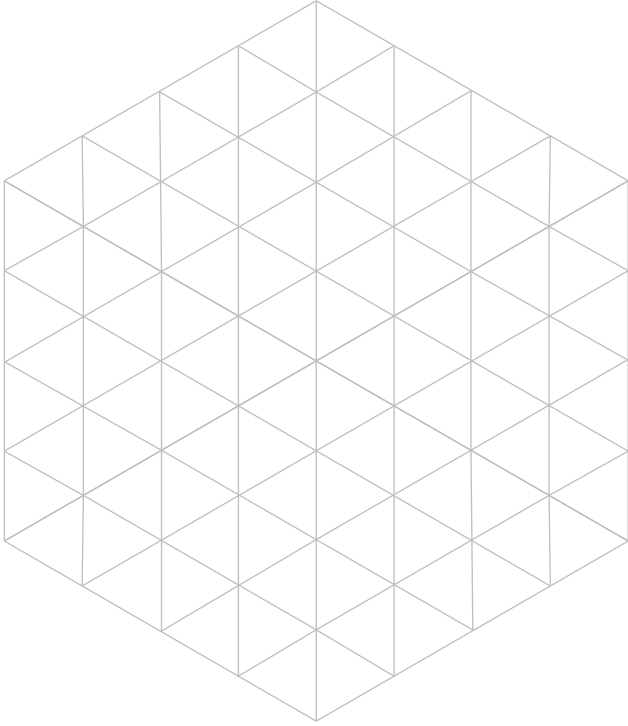
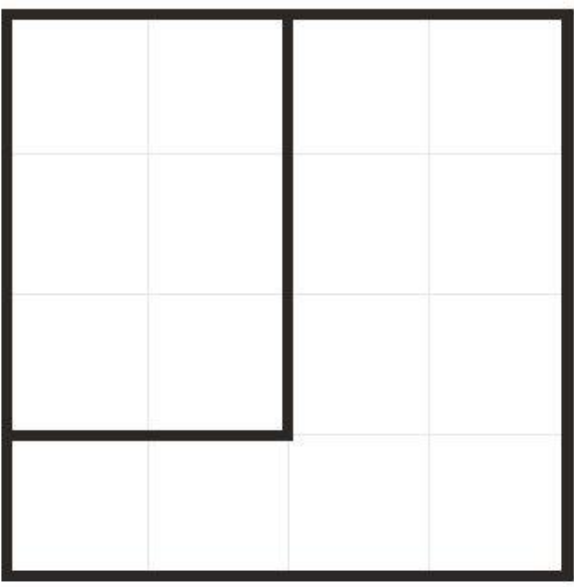
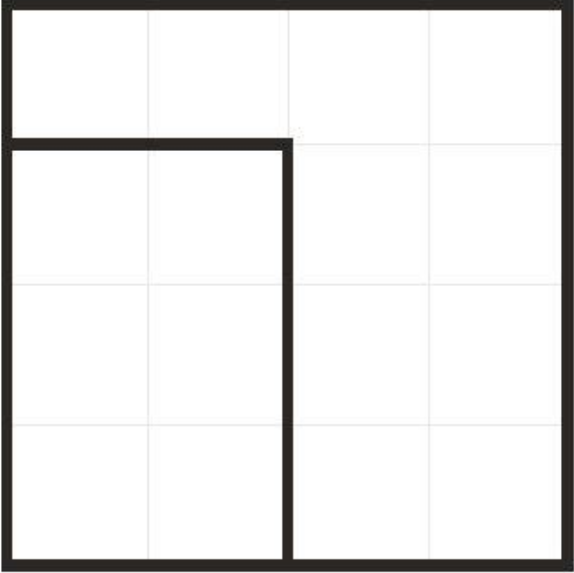
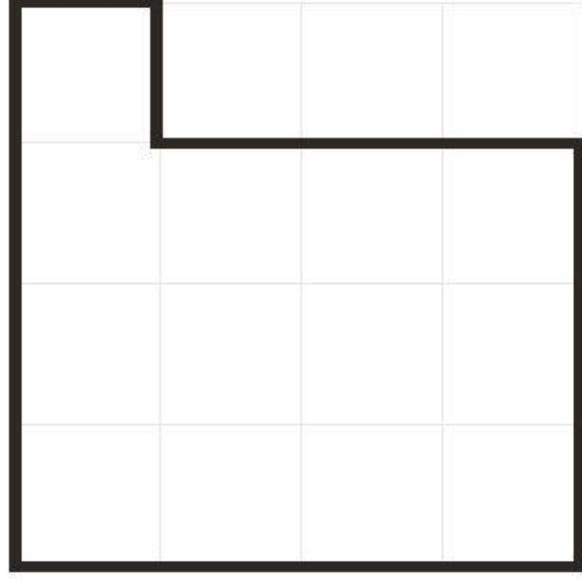
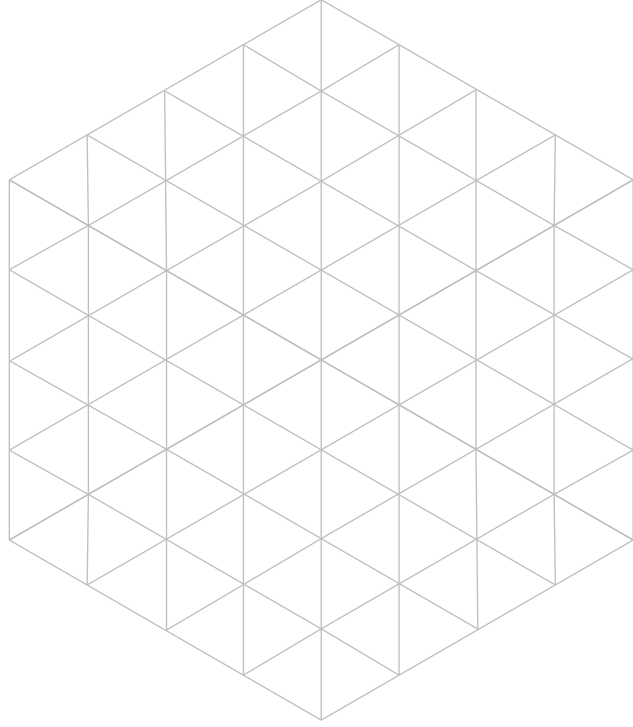
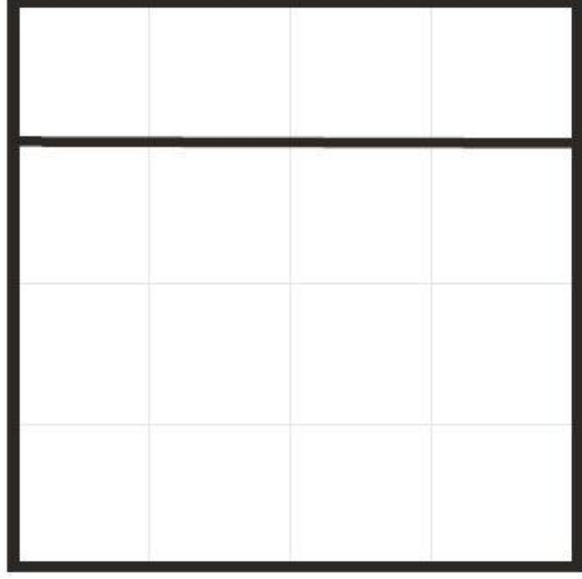
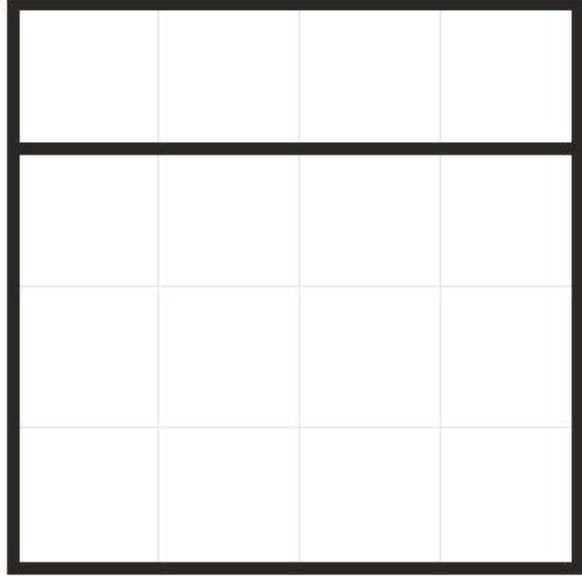

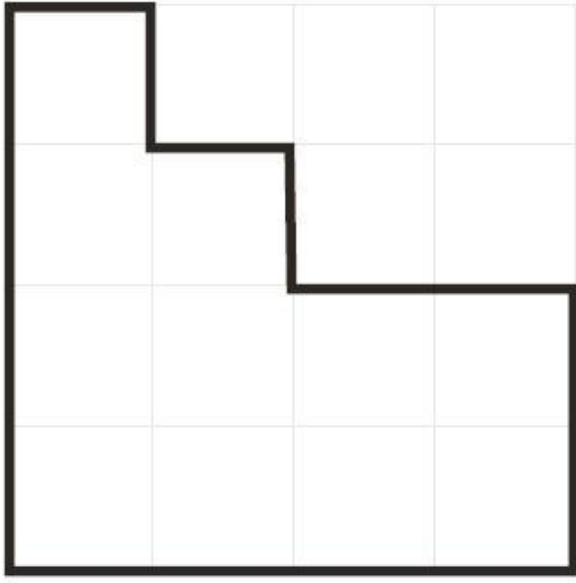
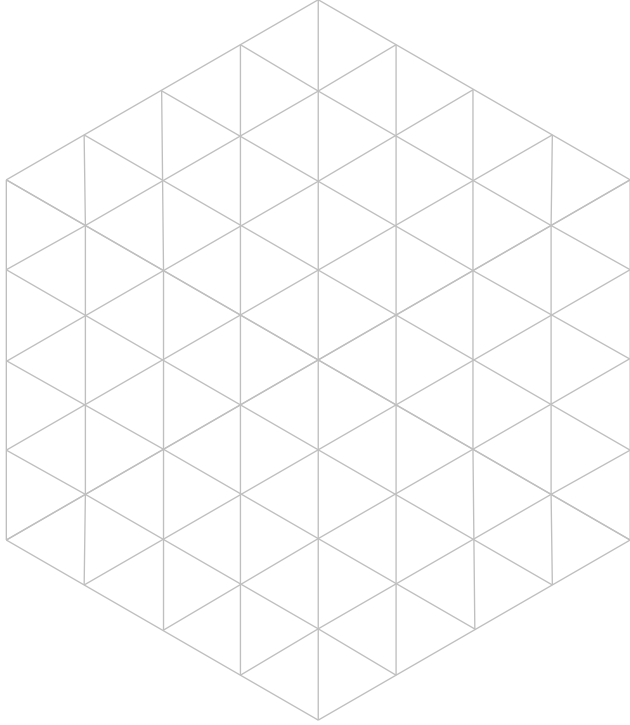
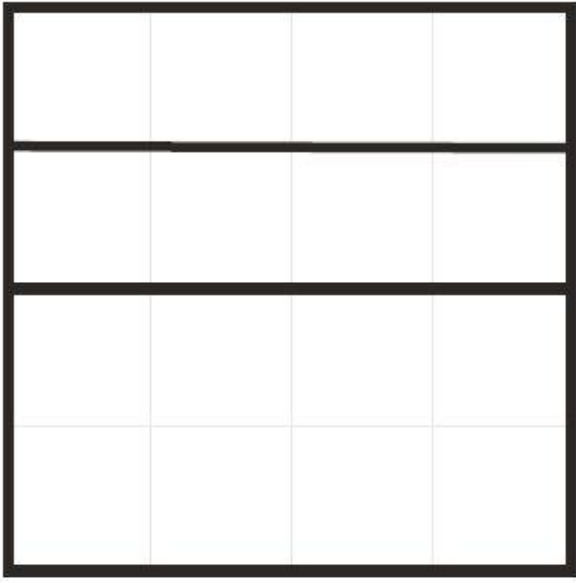
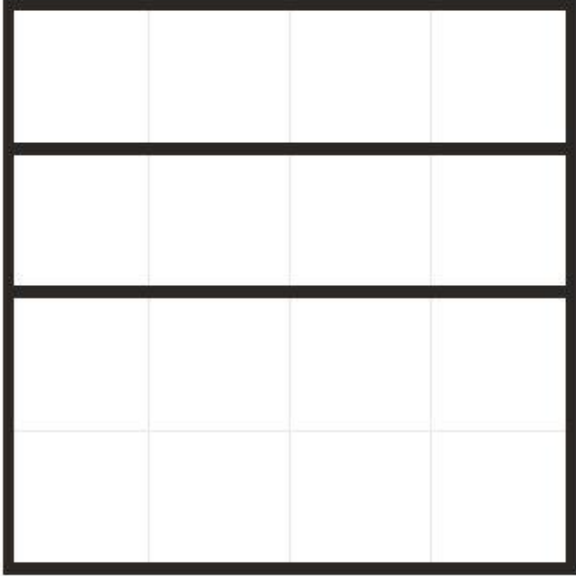

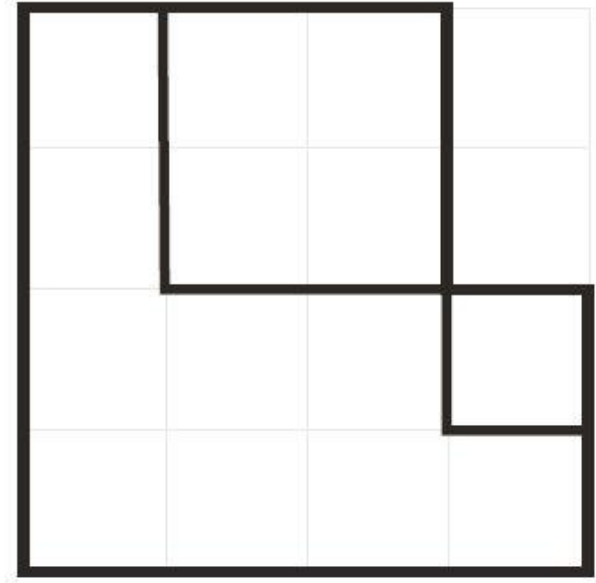
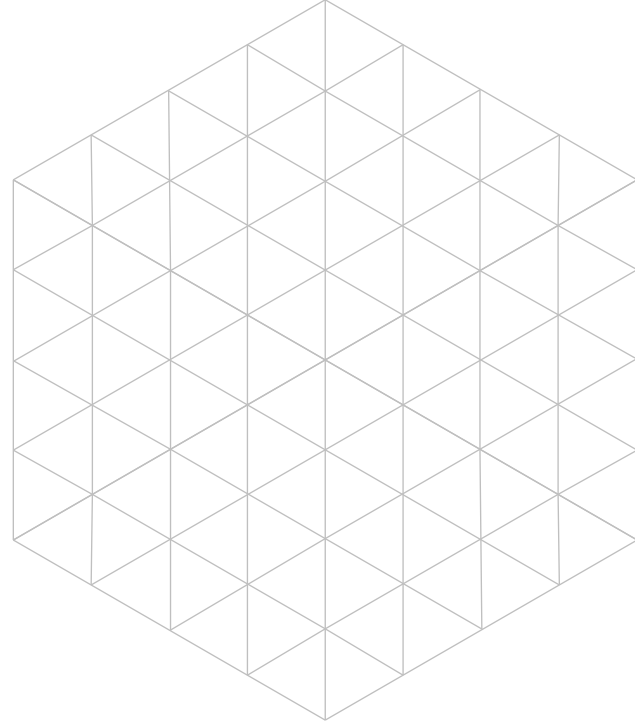
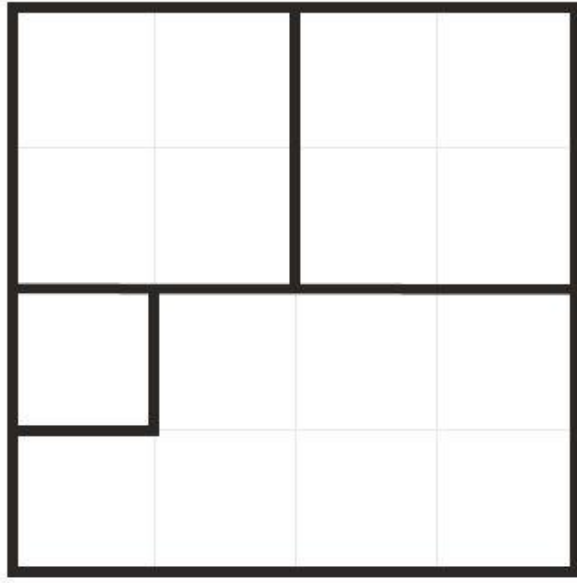
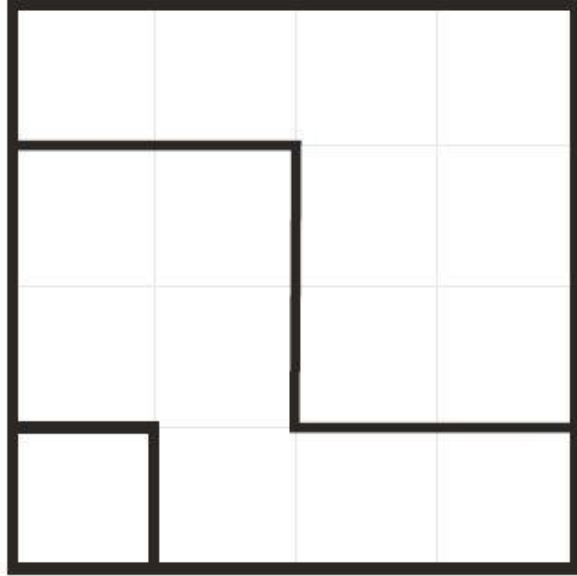

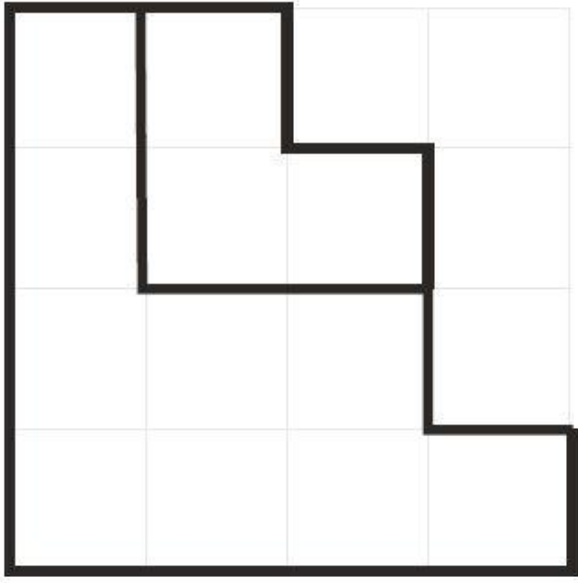
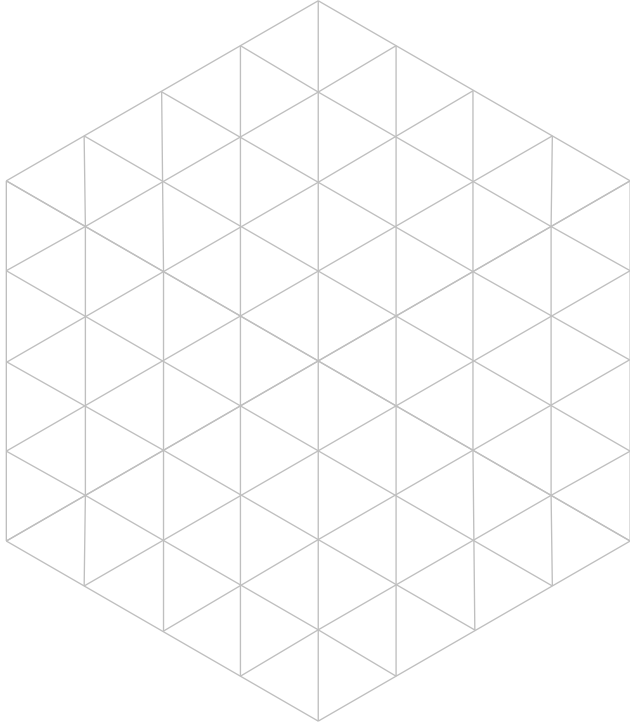
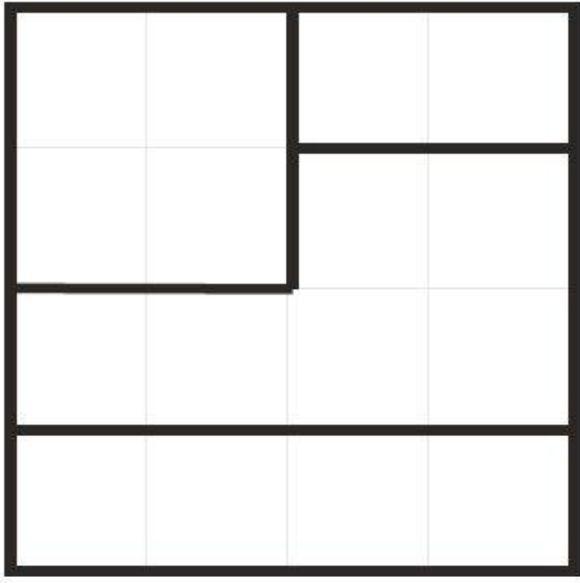
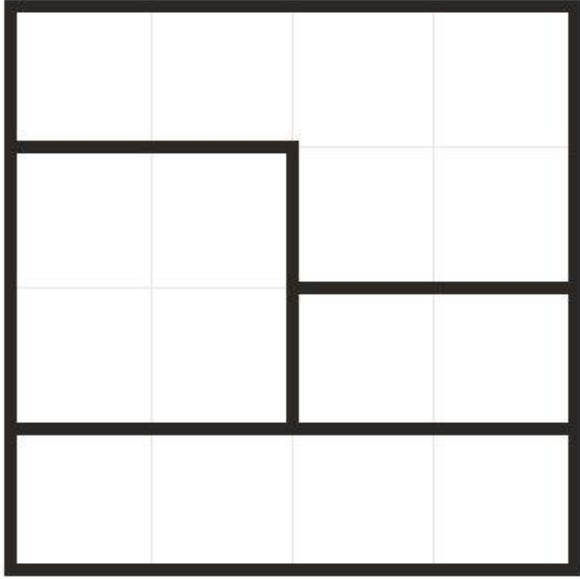

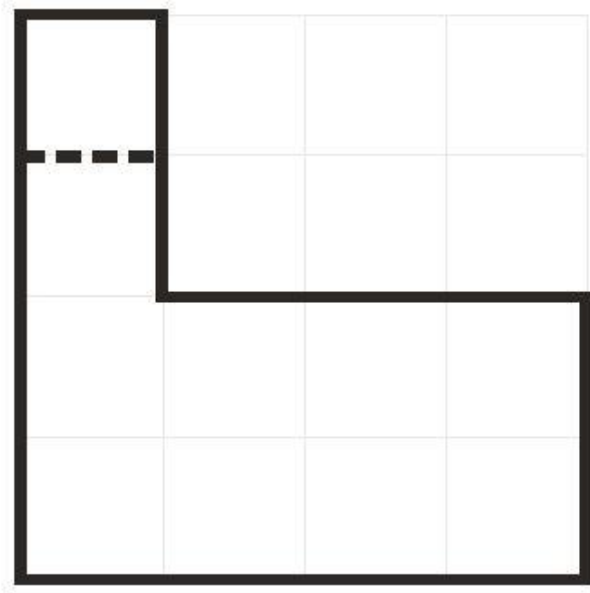
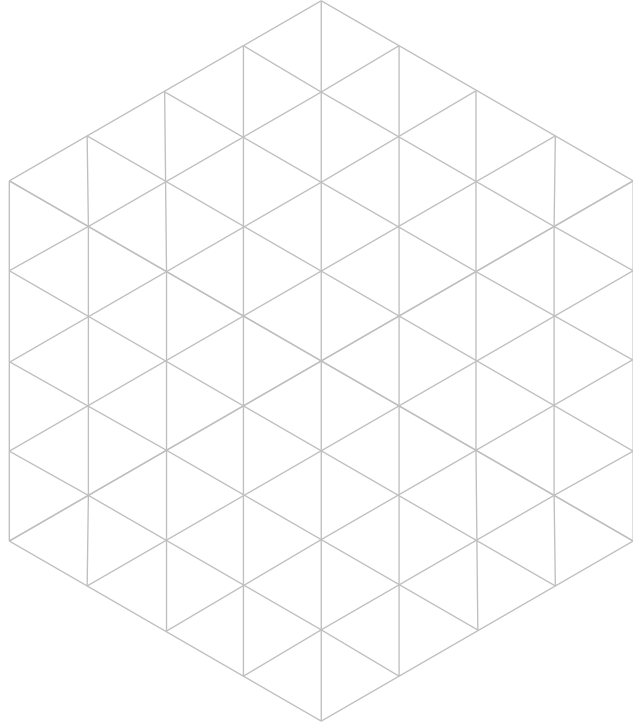
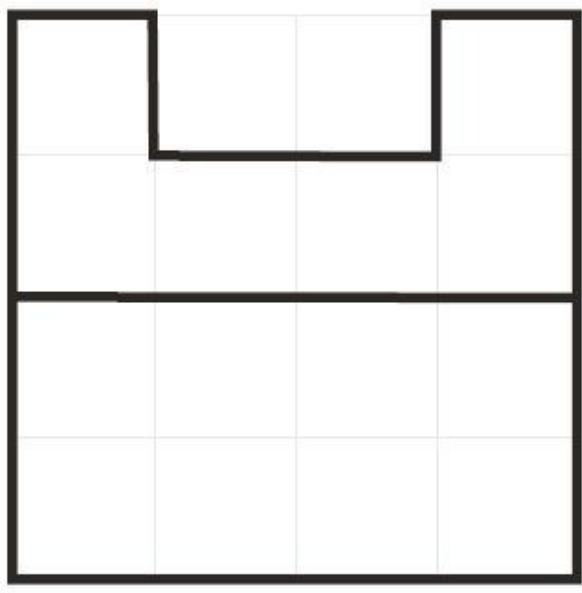
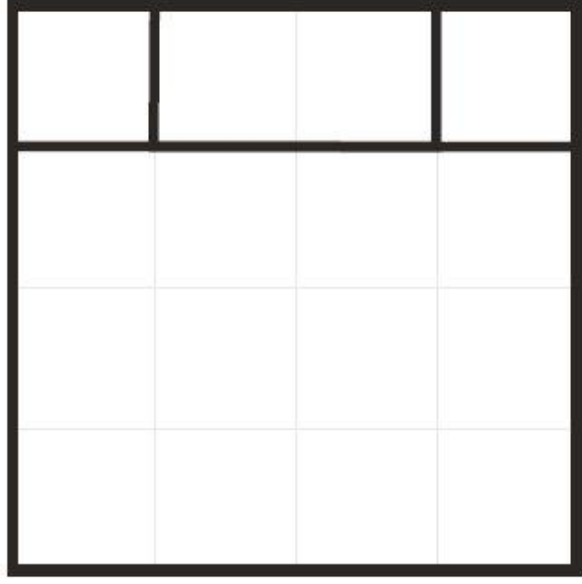

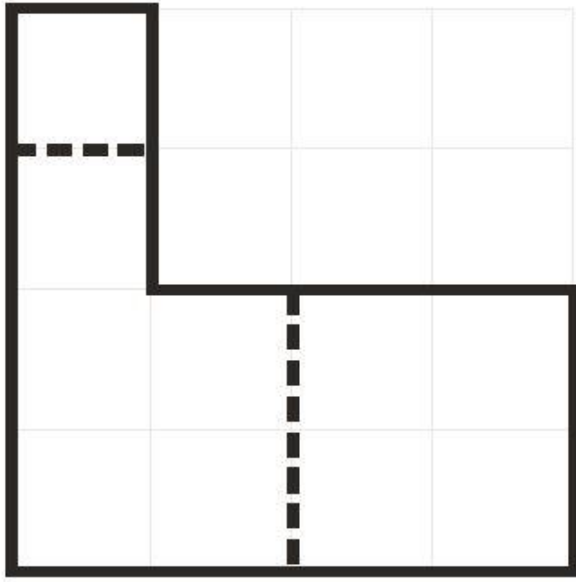
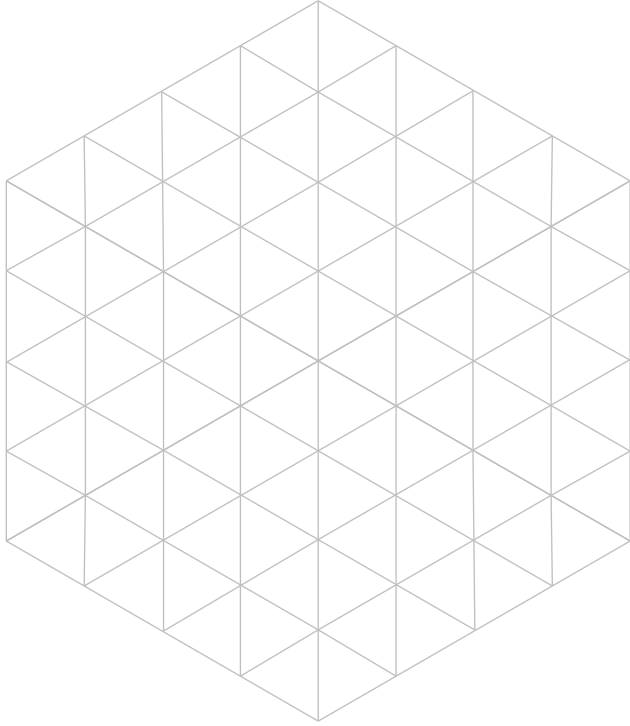
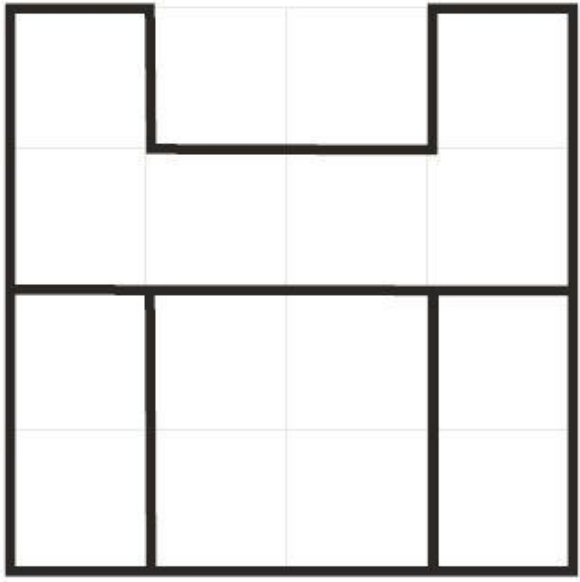
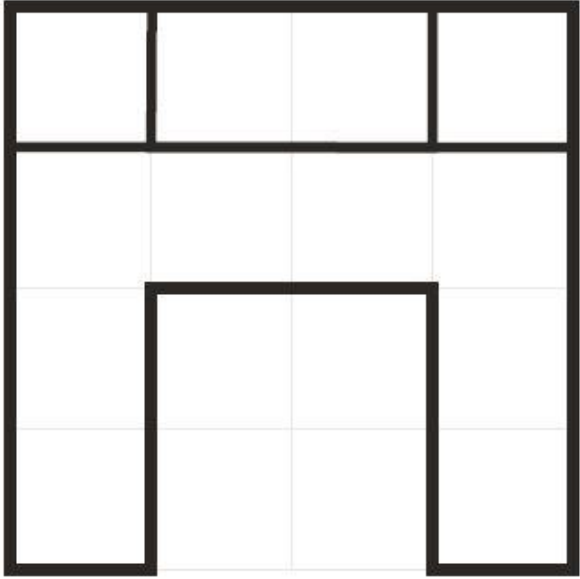

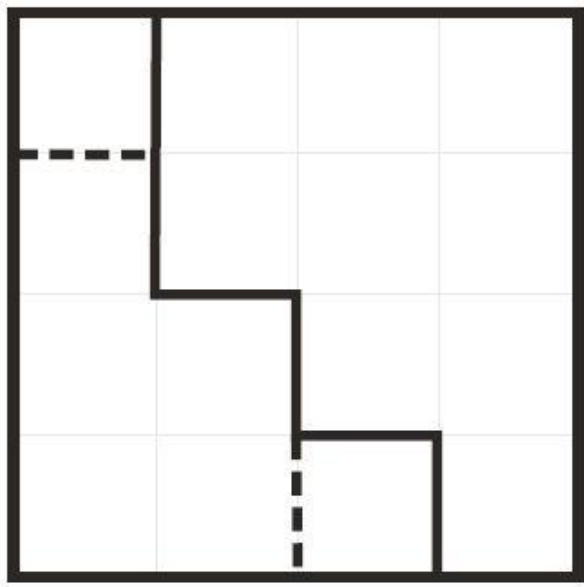
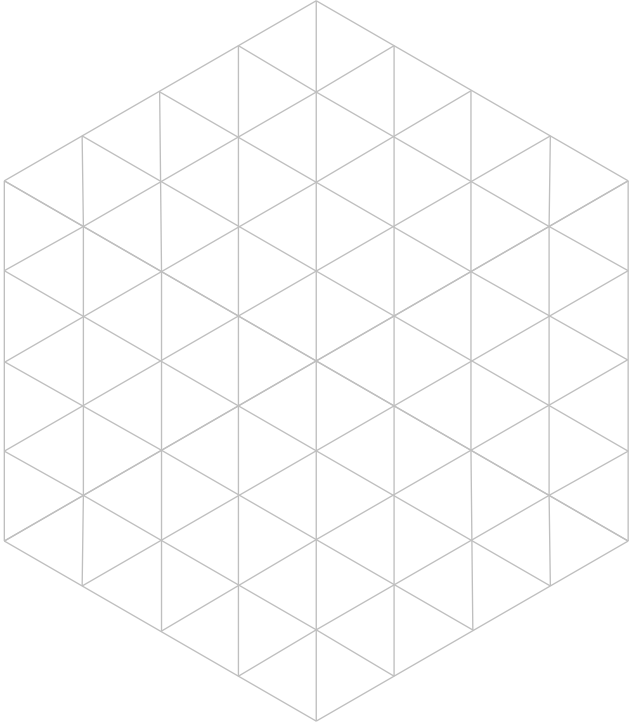
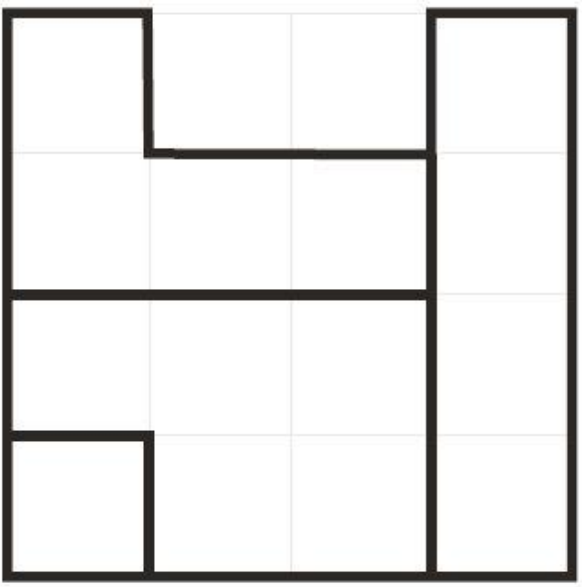
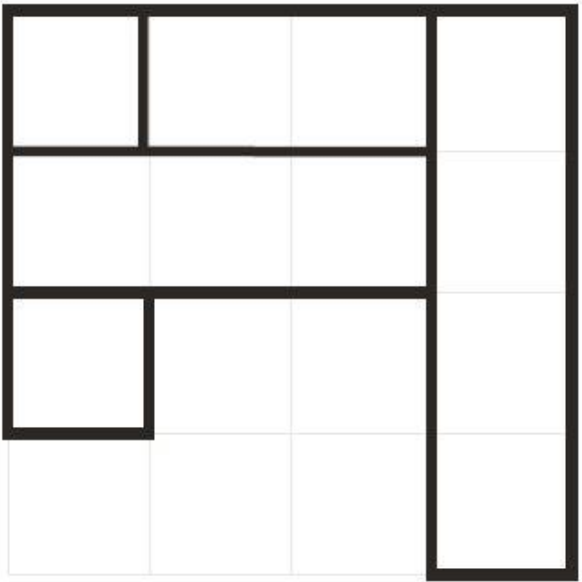

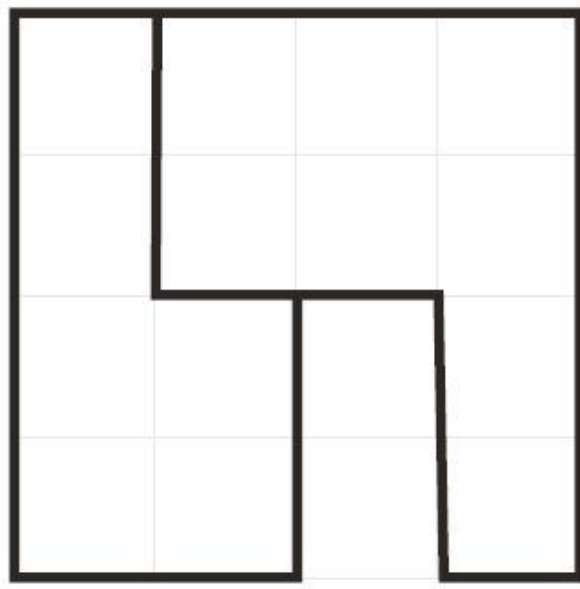
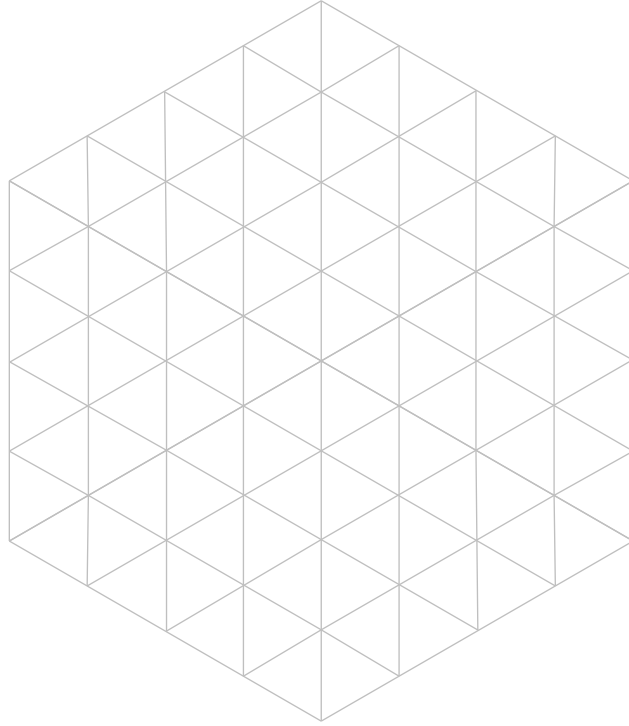
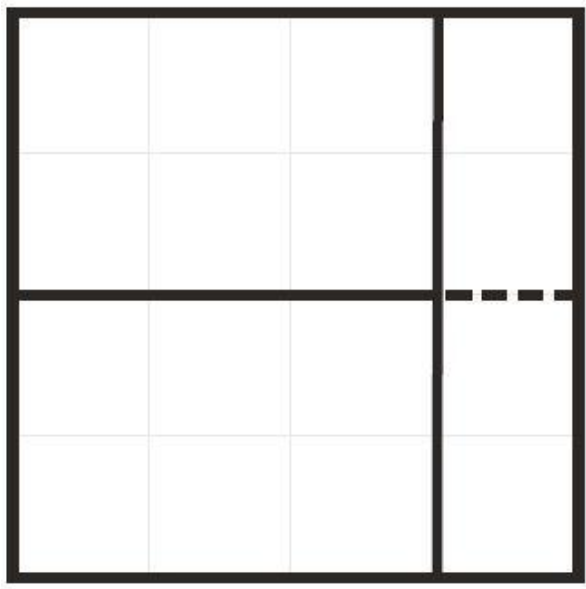
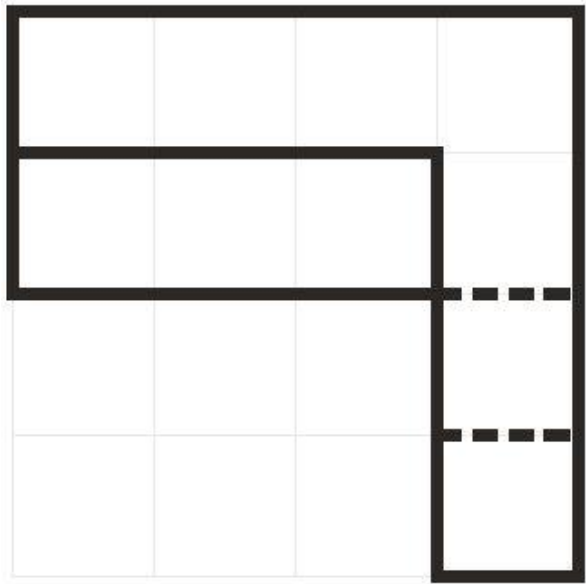

Pieza 10

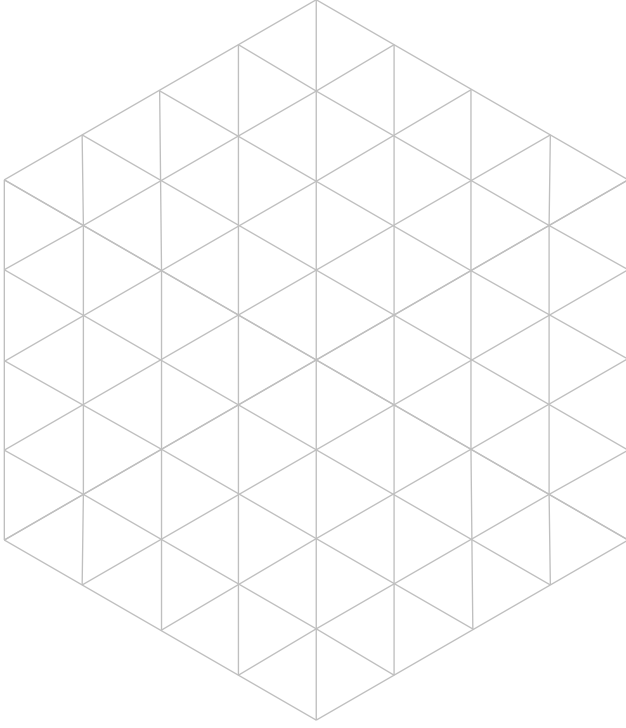
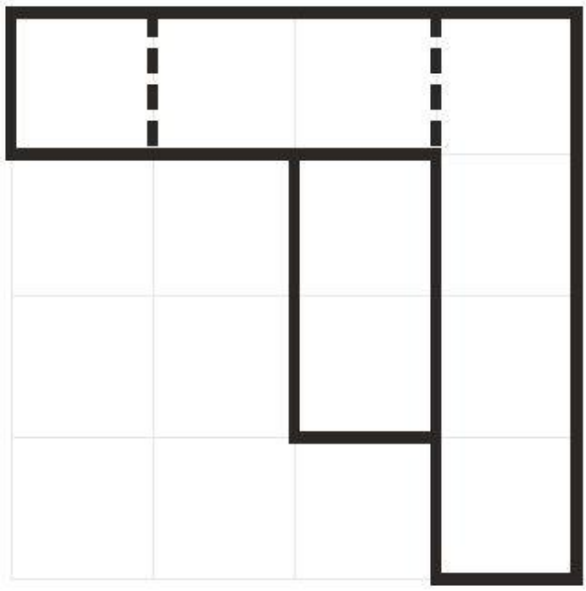
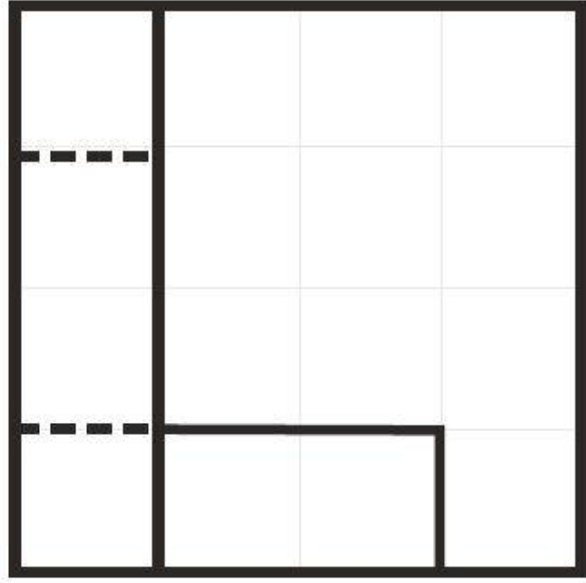
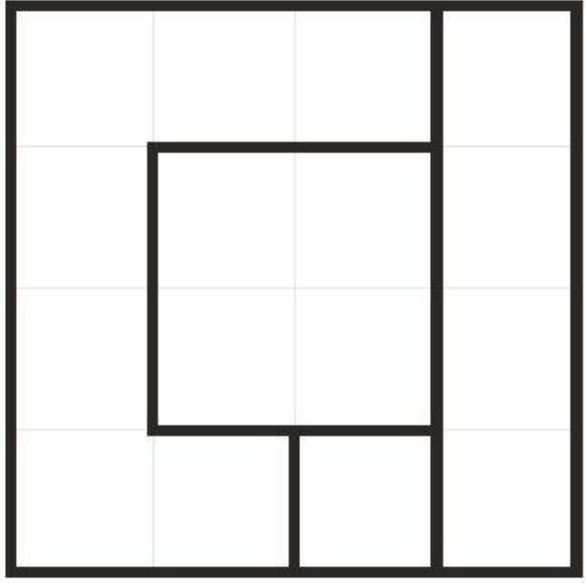

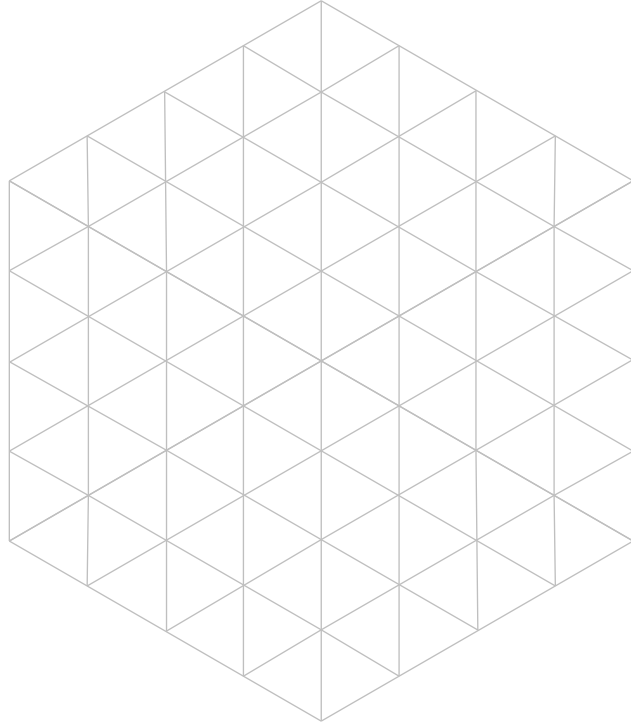
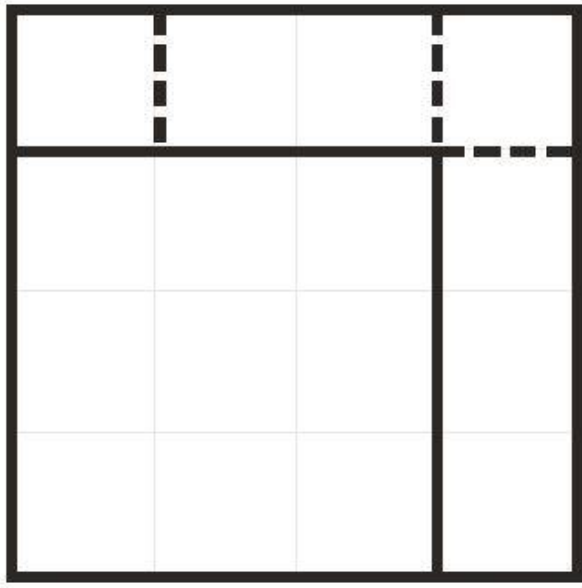
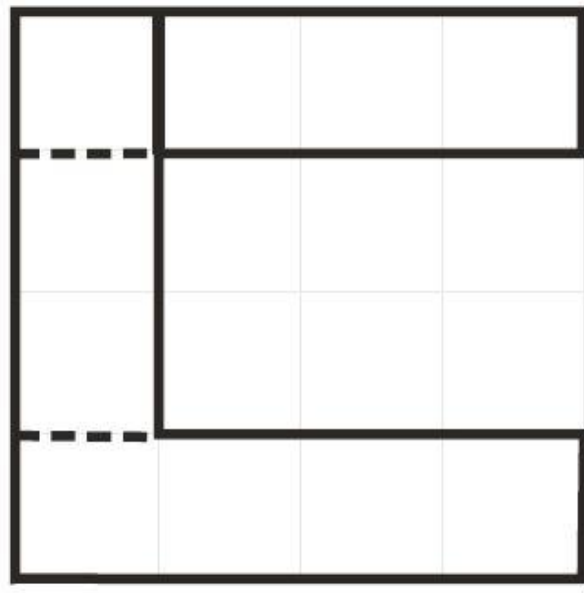
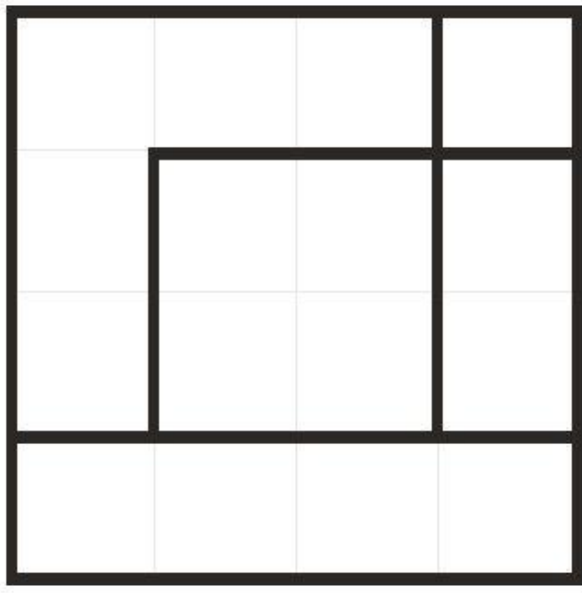

Pieza 13

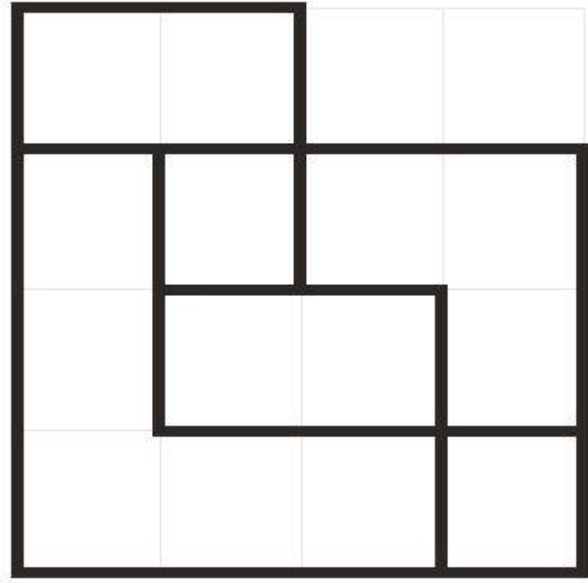
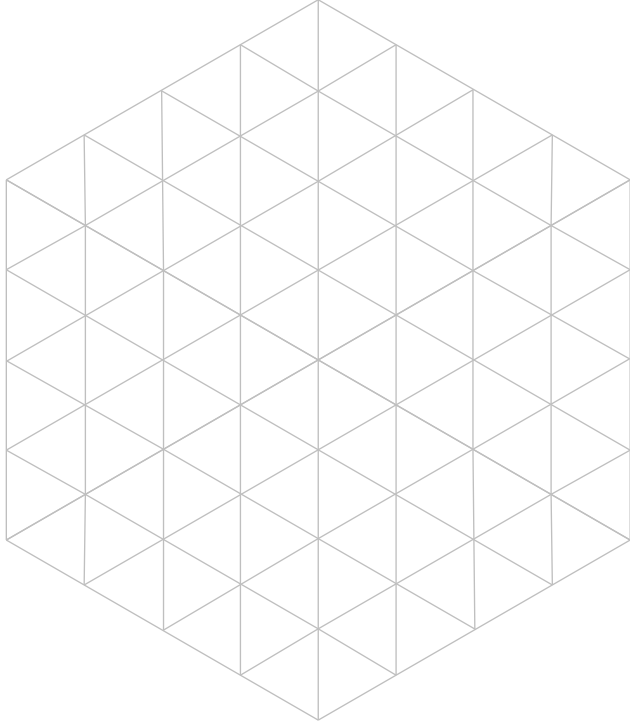
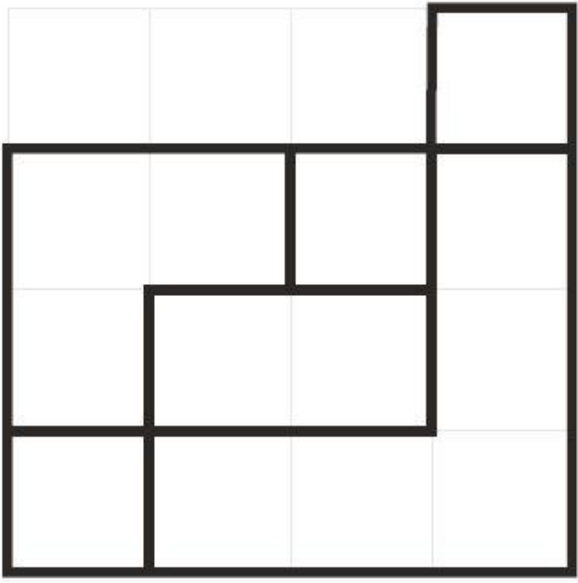
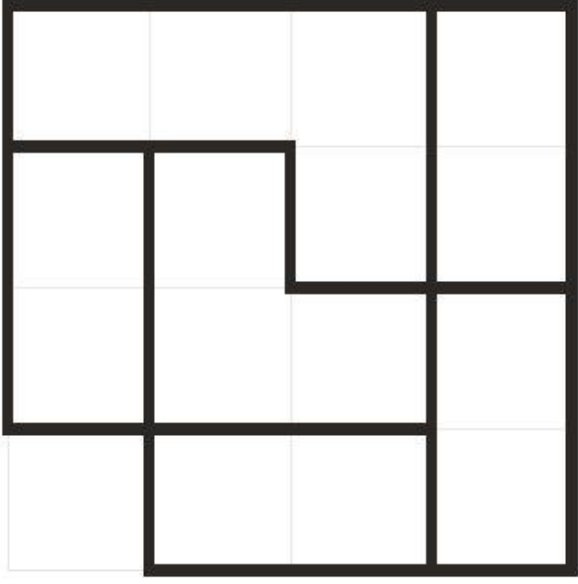

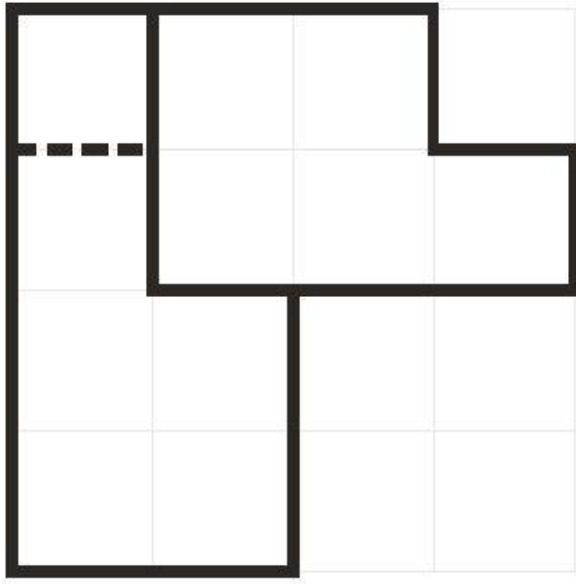
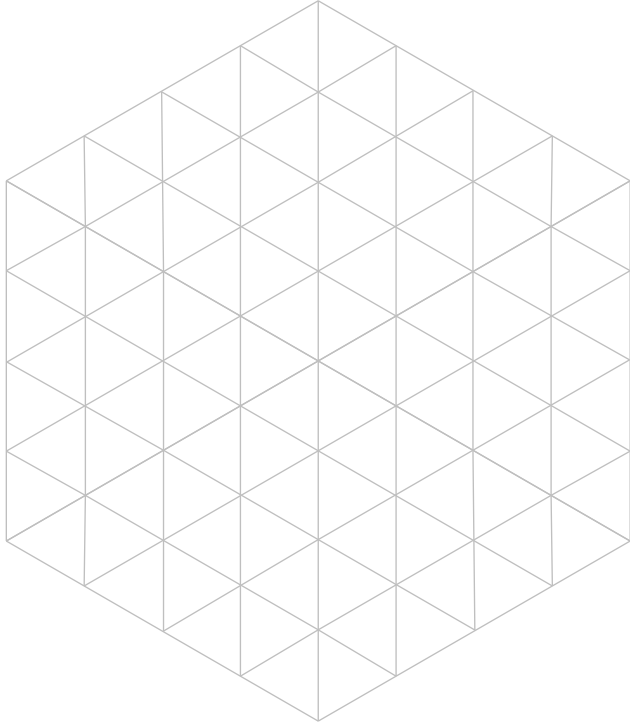
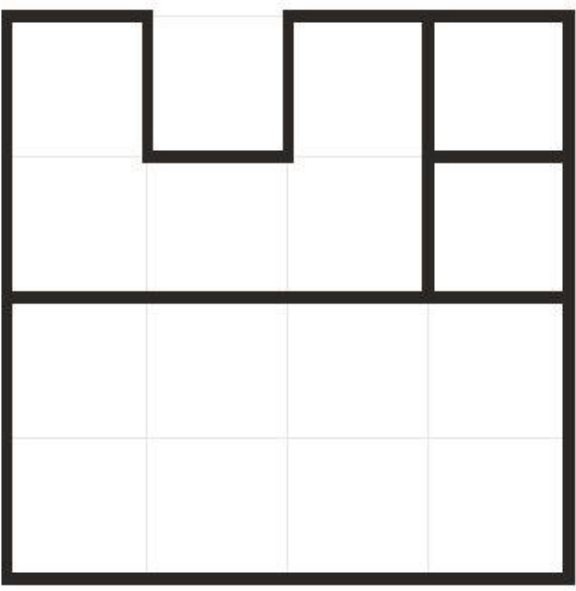
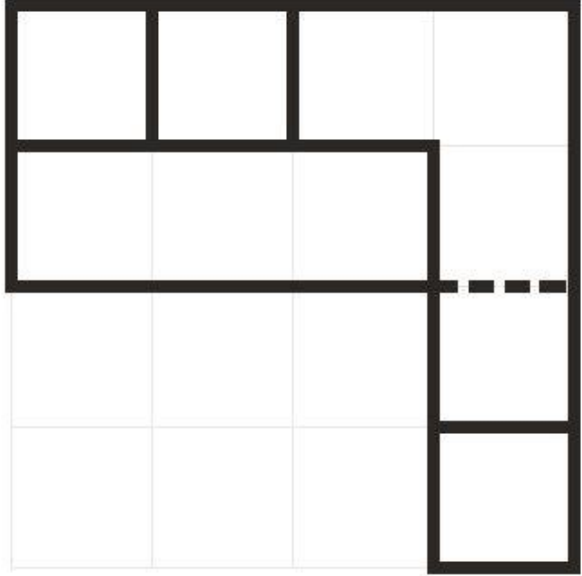

Pieza 16

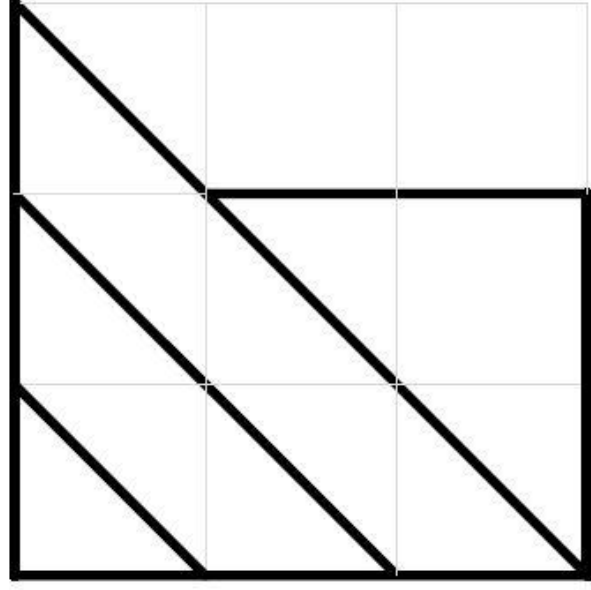
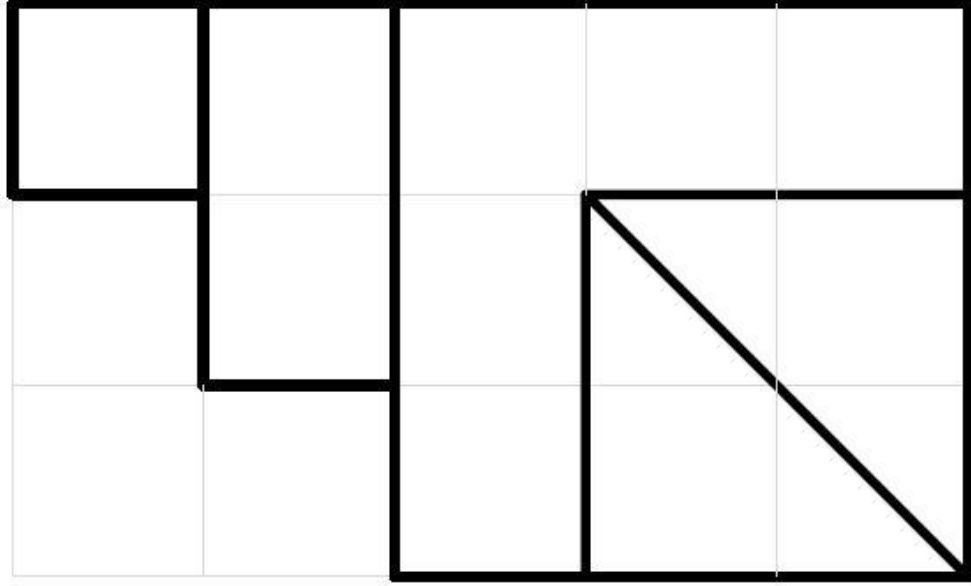
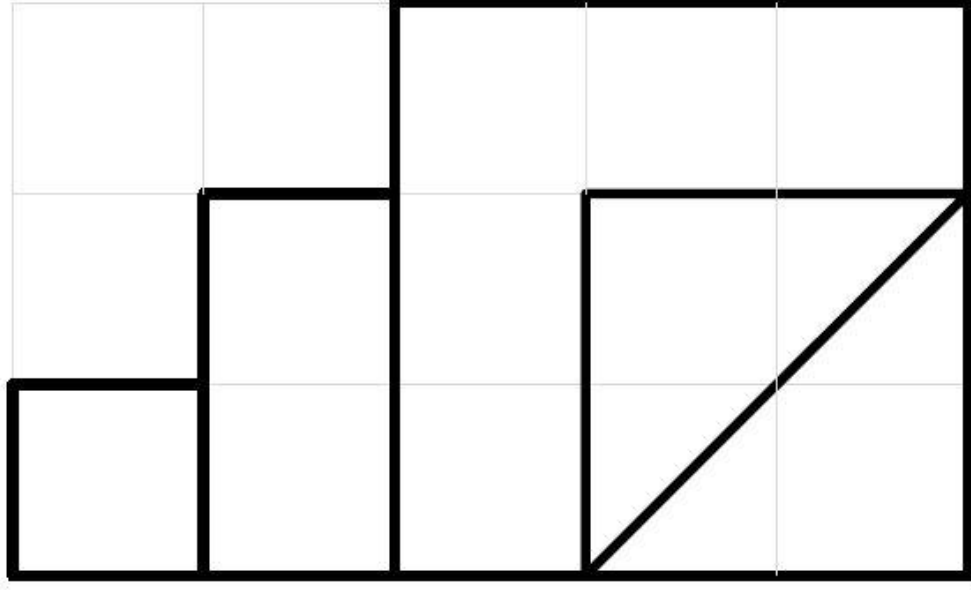

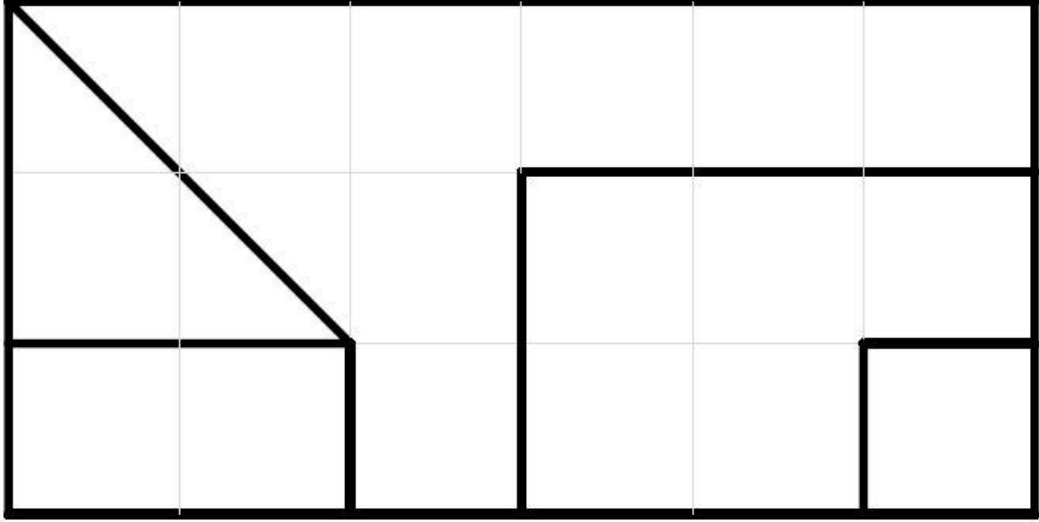
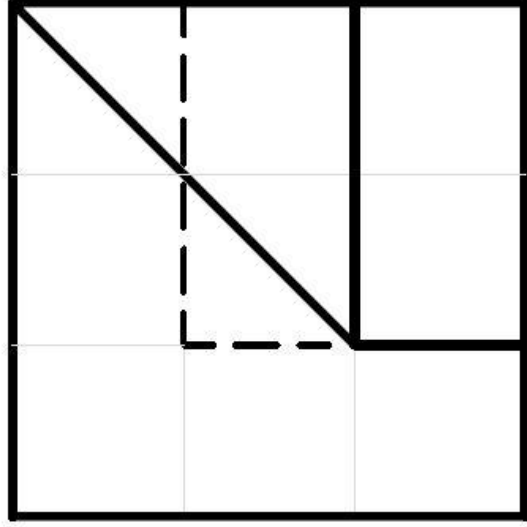
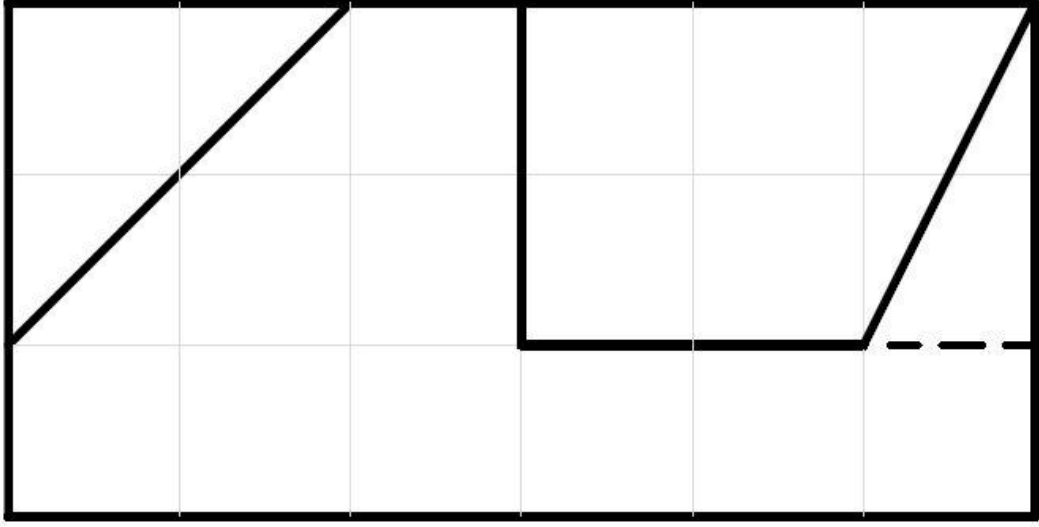

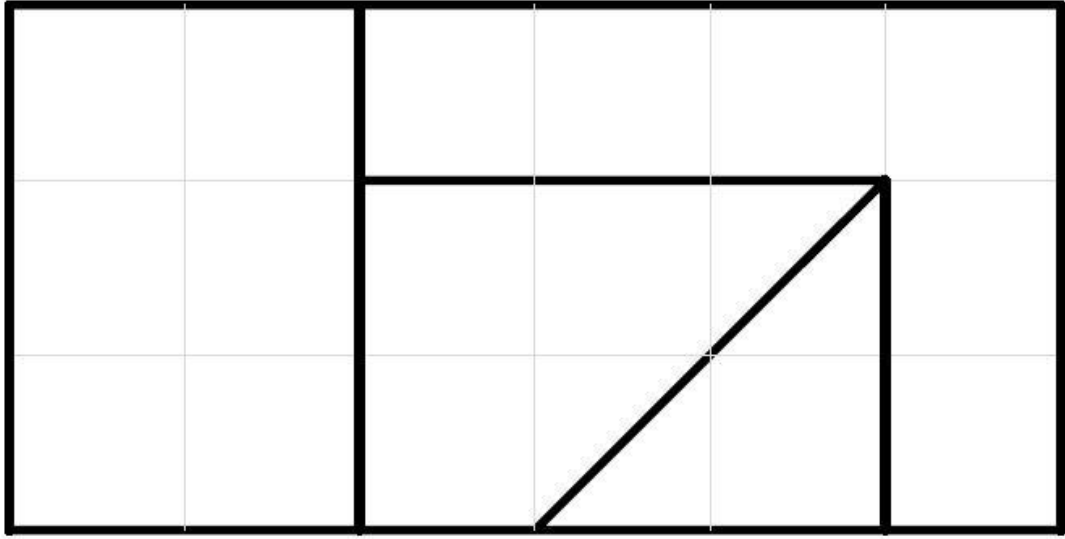
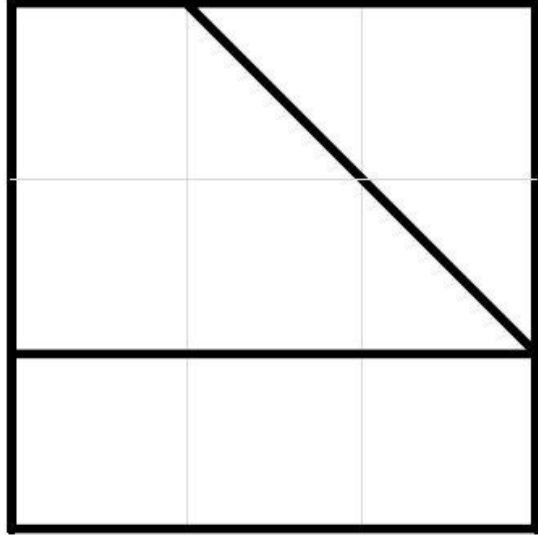
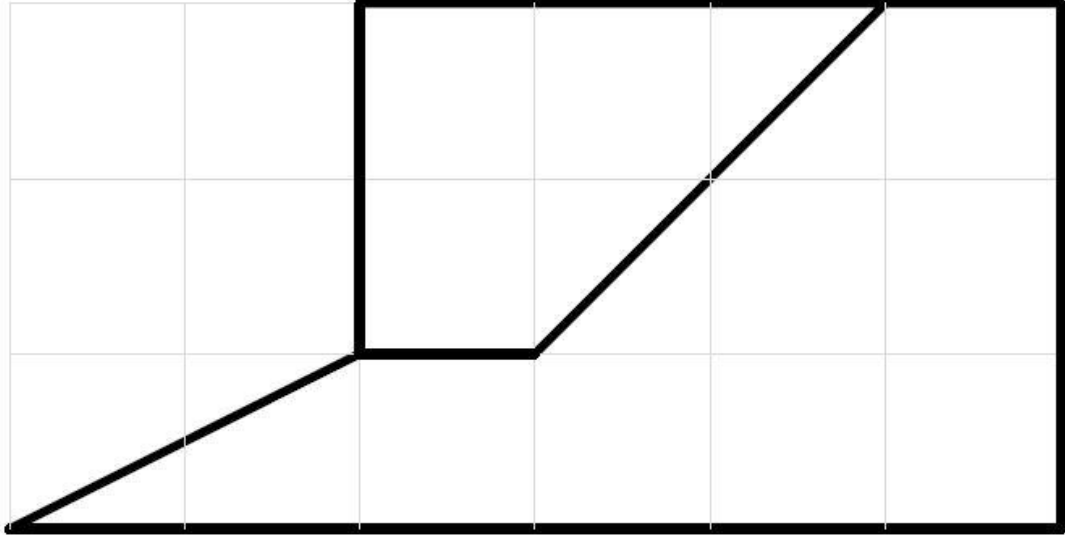

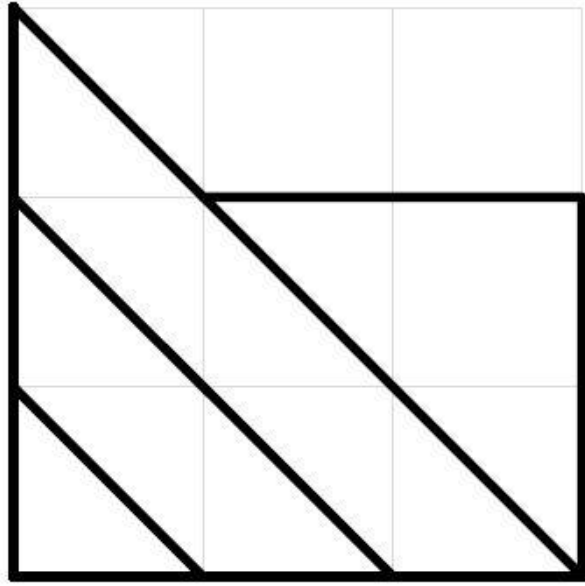
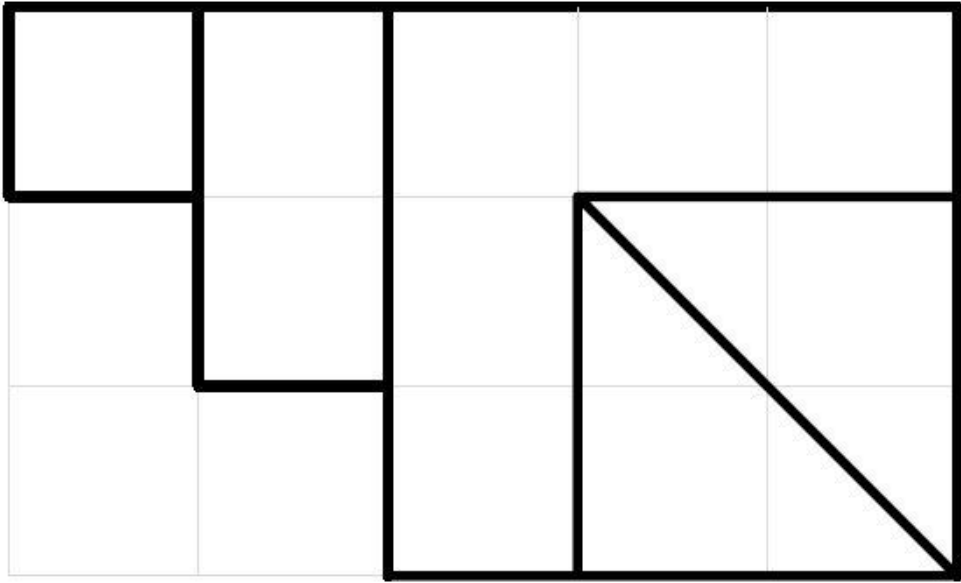
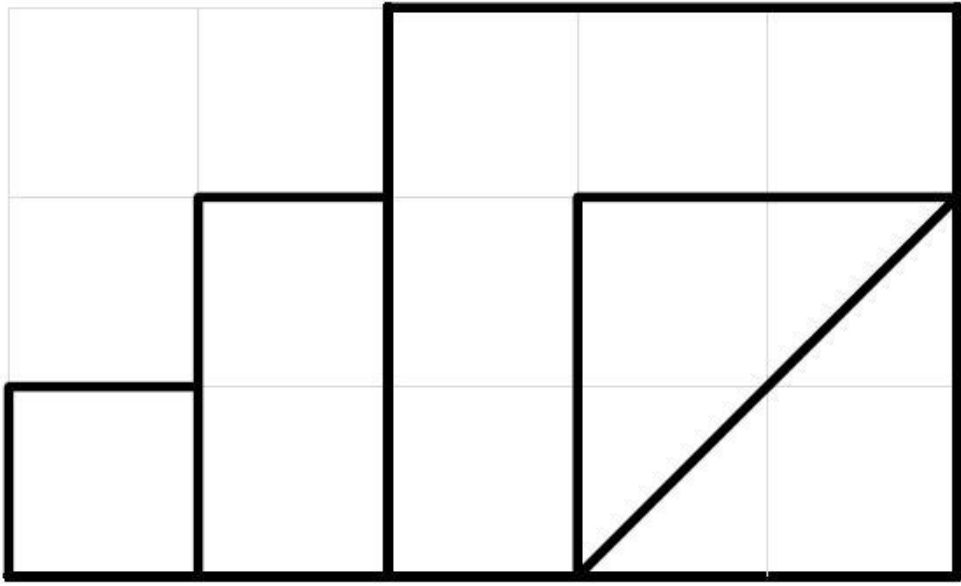

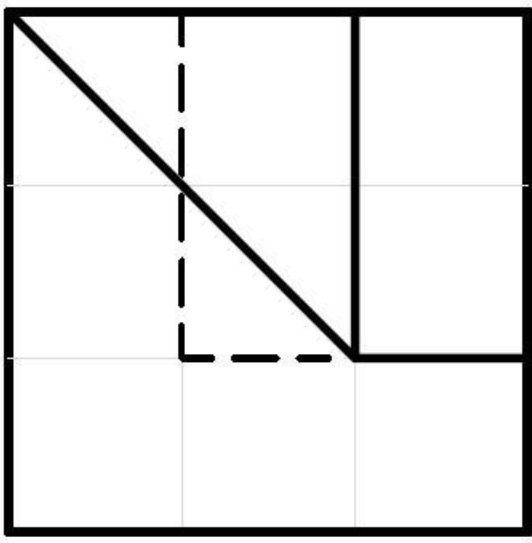
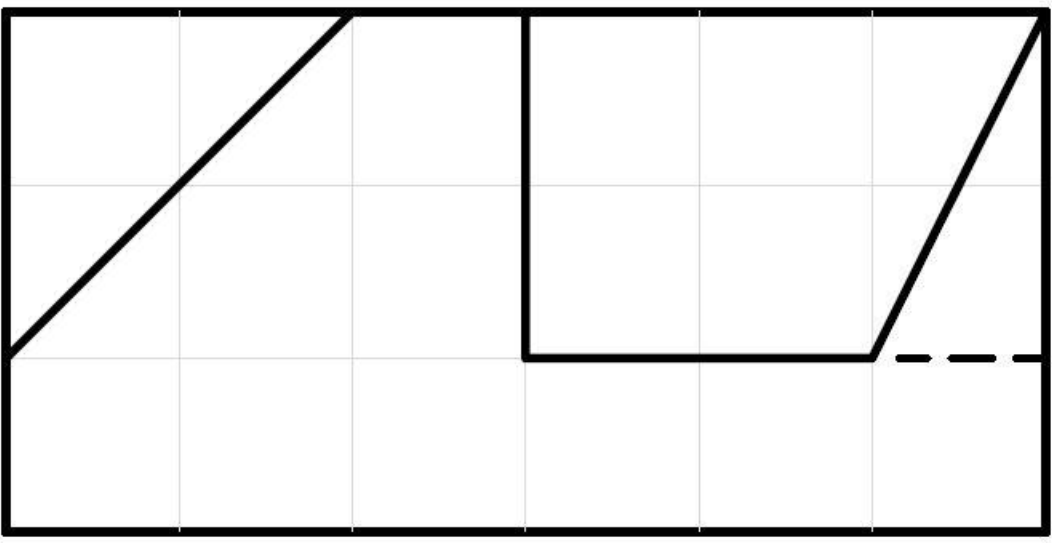
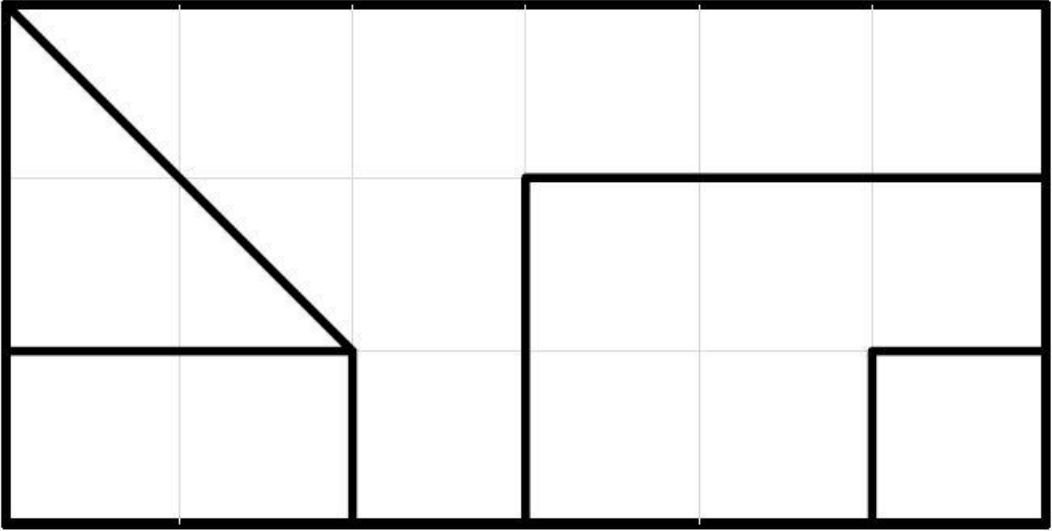

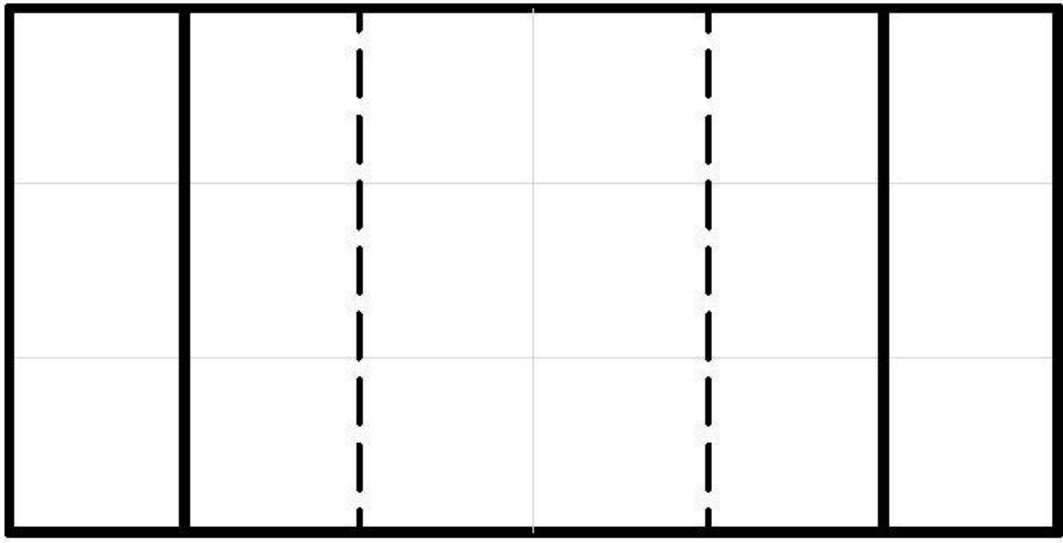
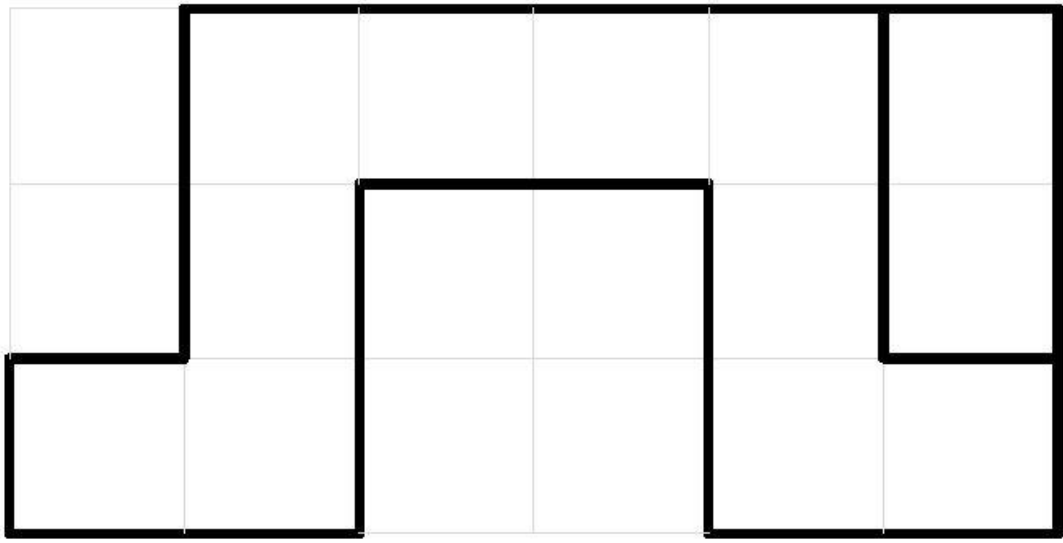
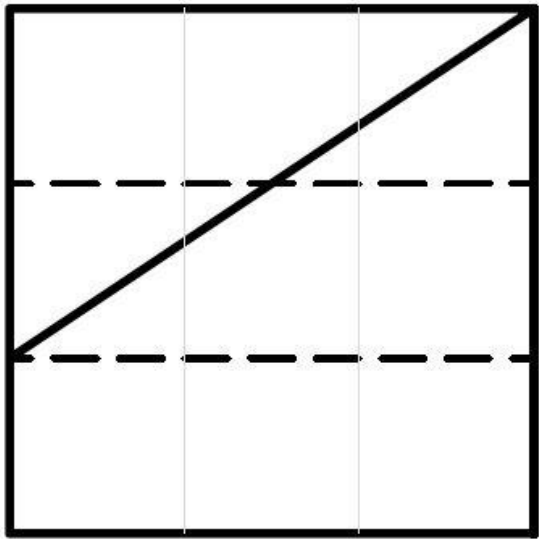

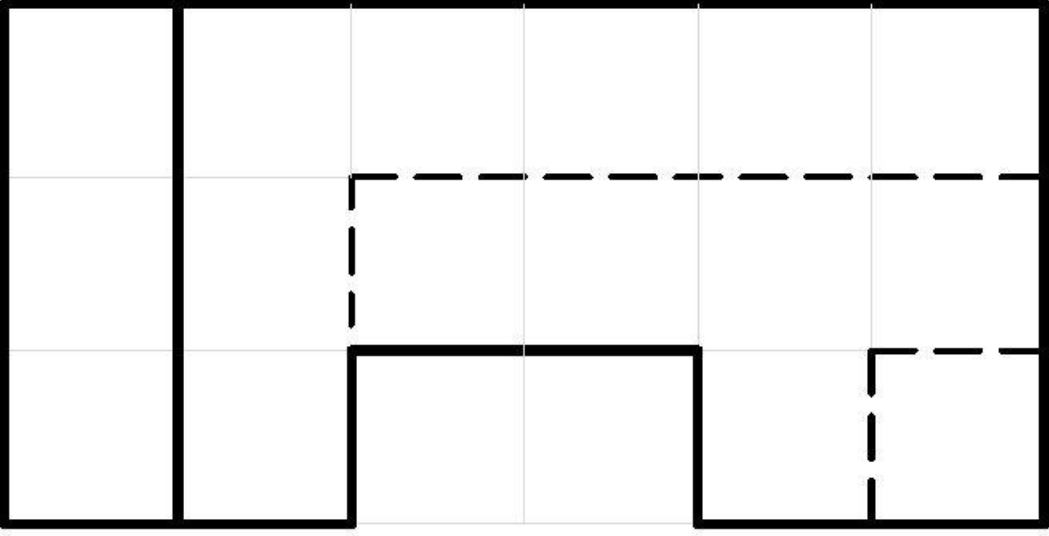
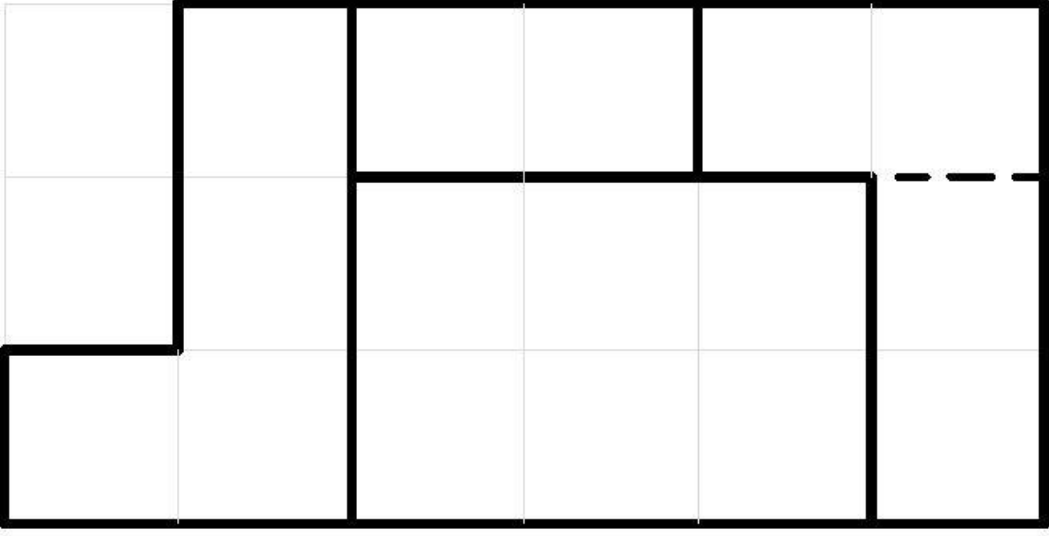
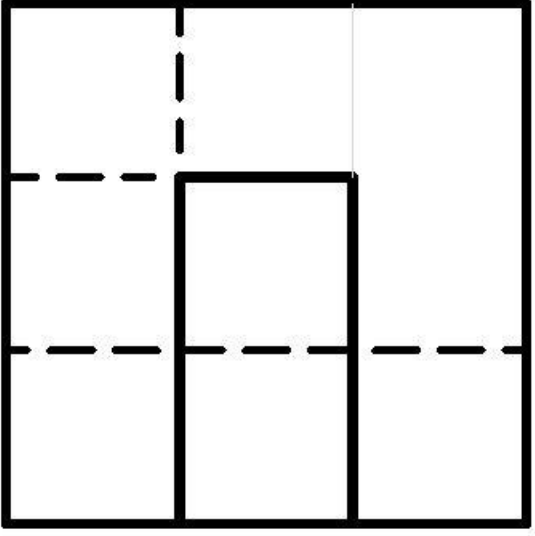

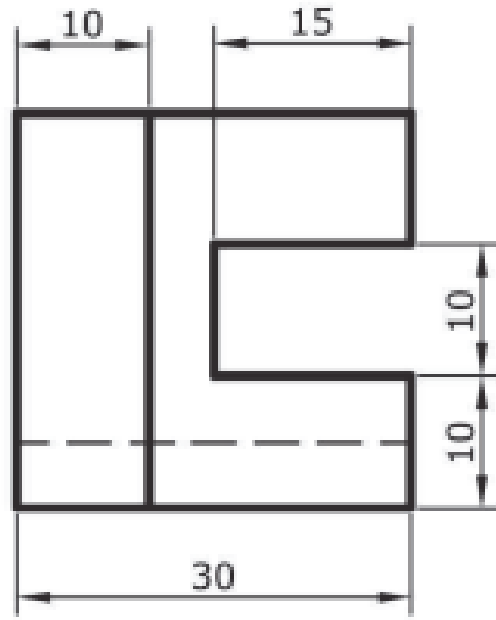
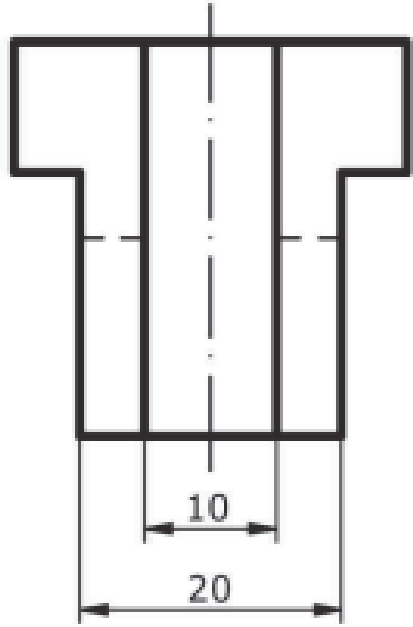
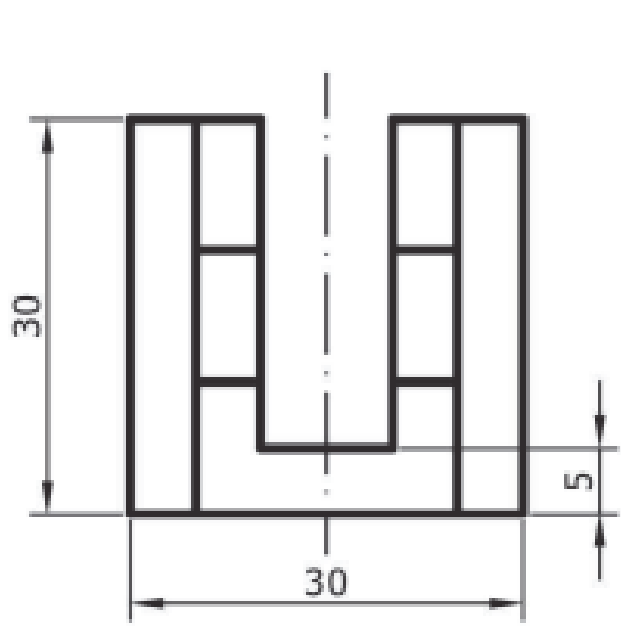

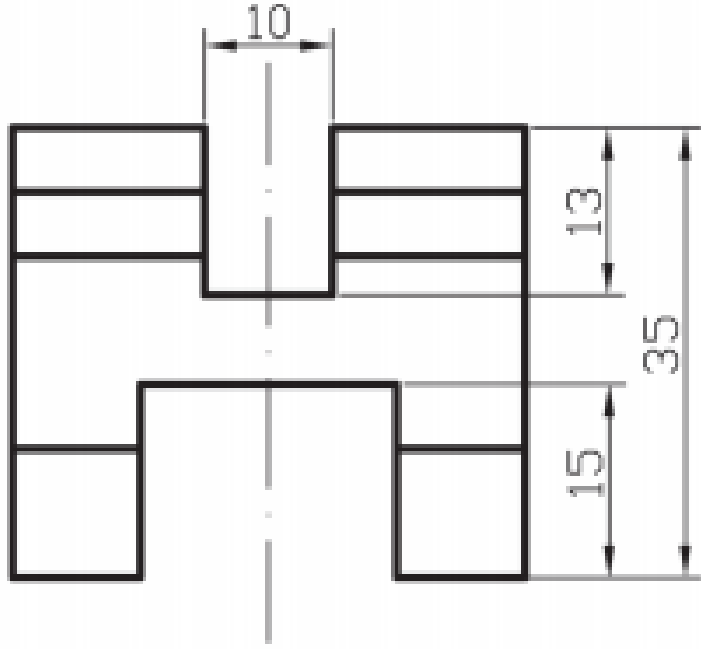
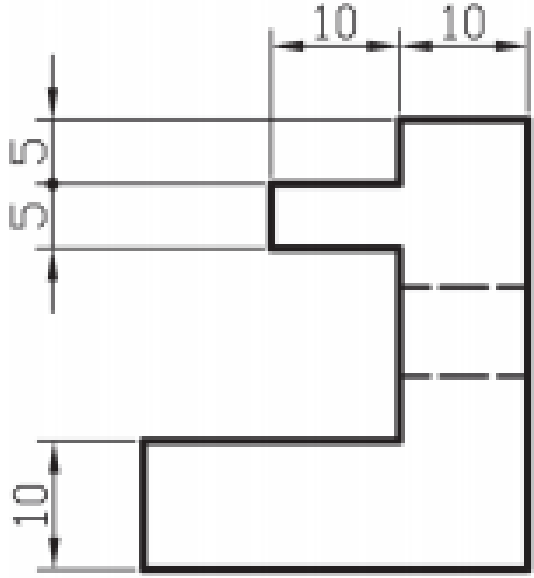
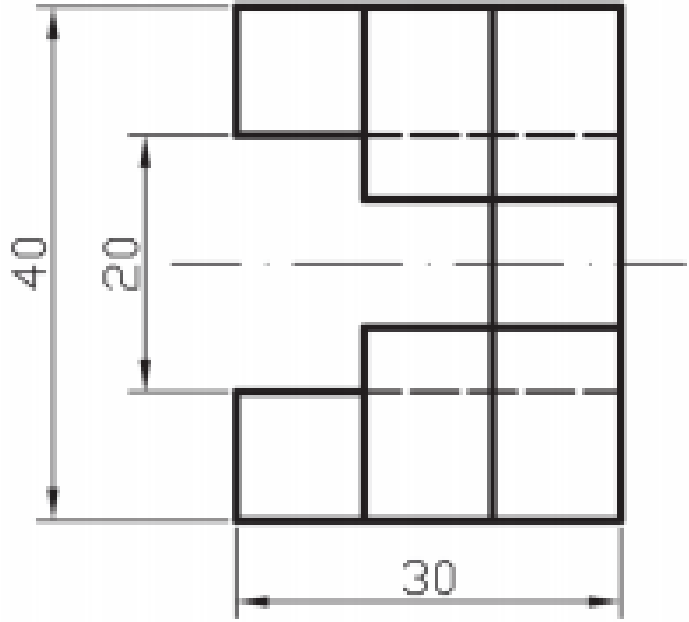

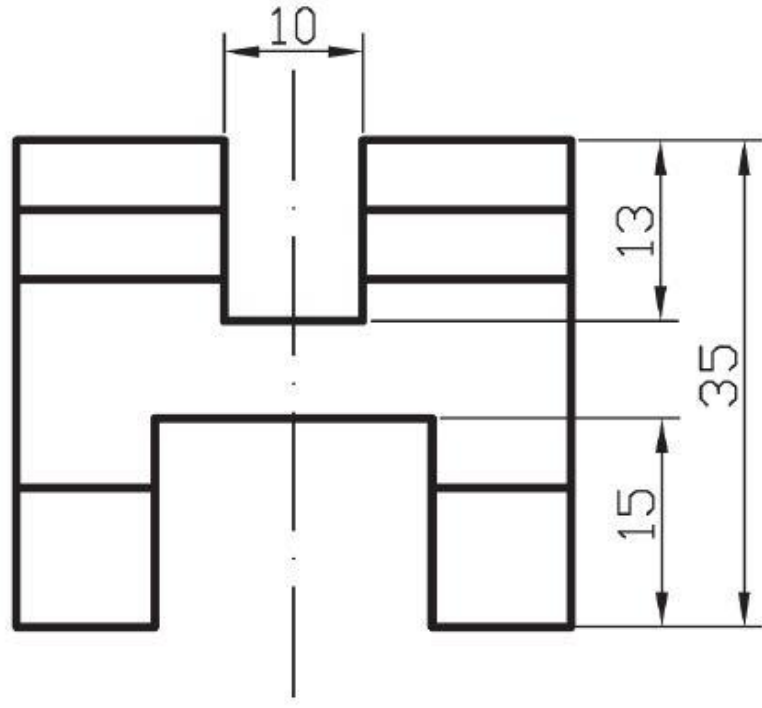
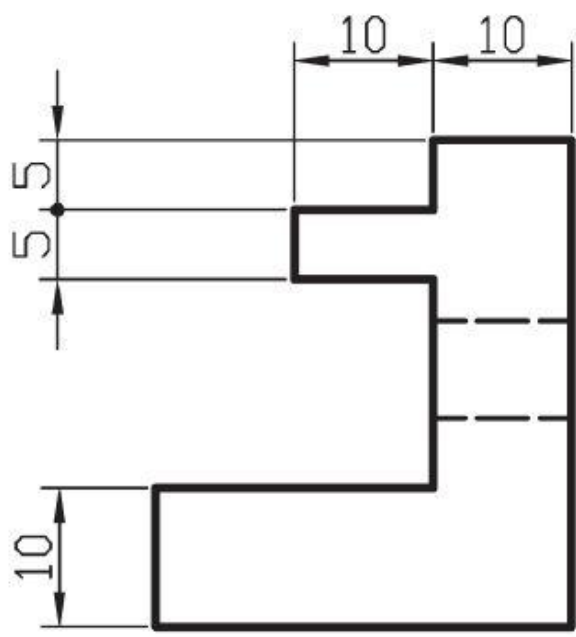
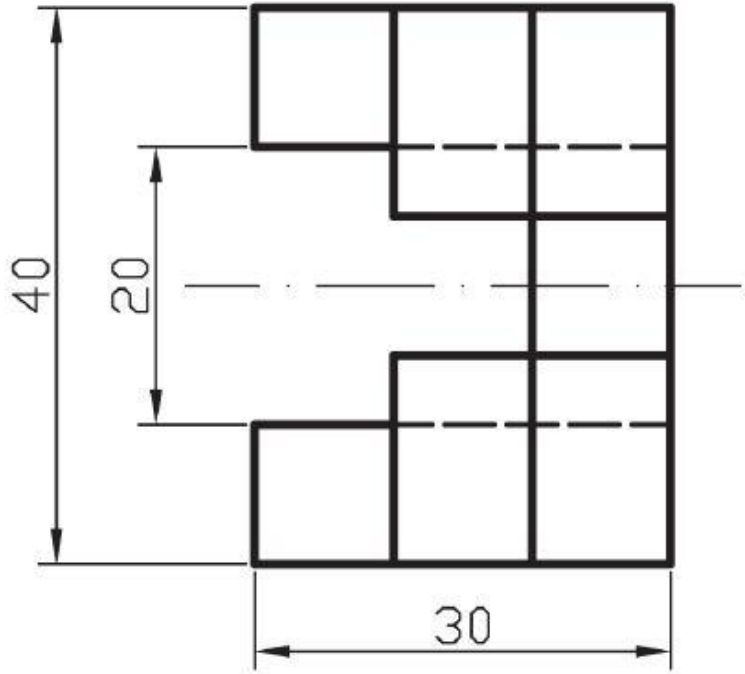

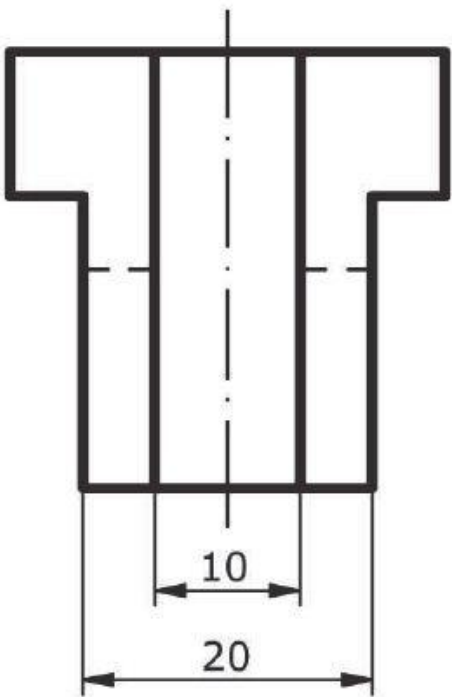
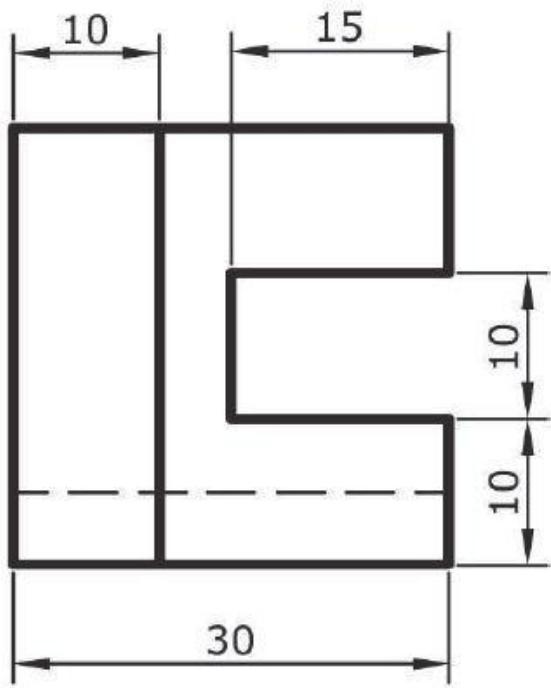
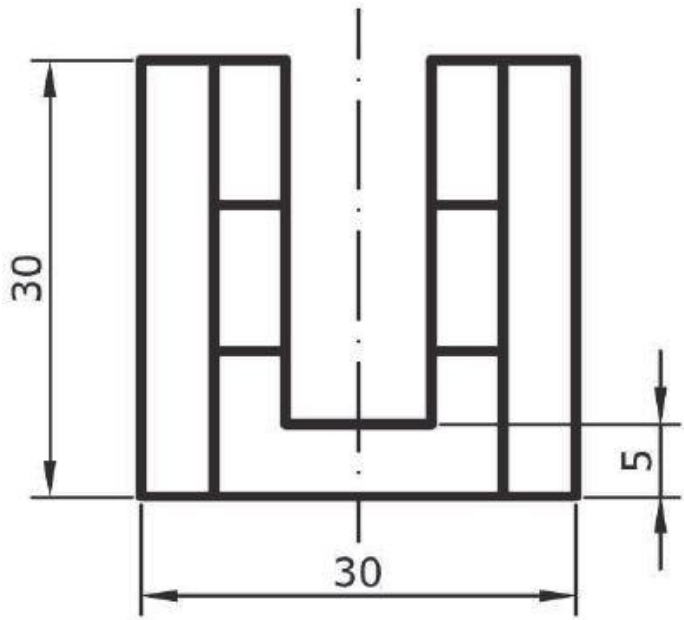

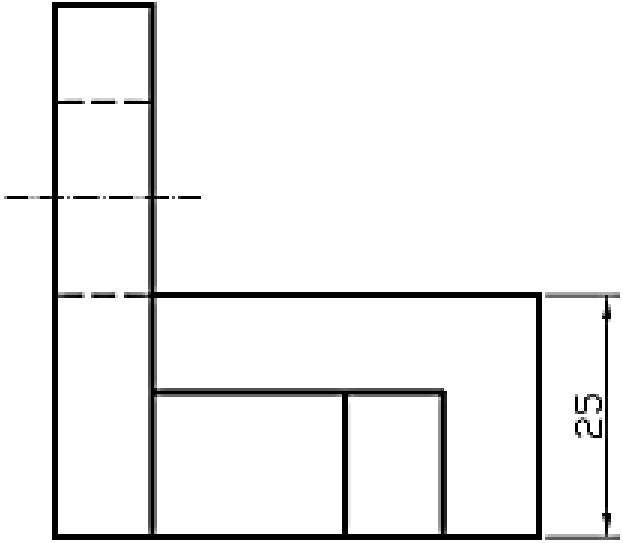
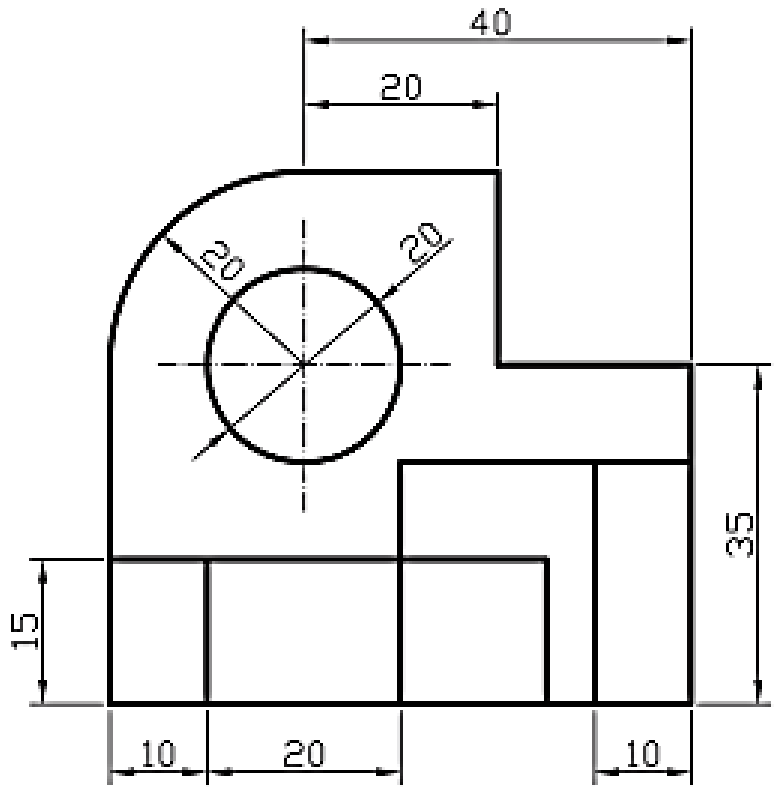
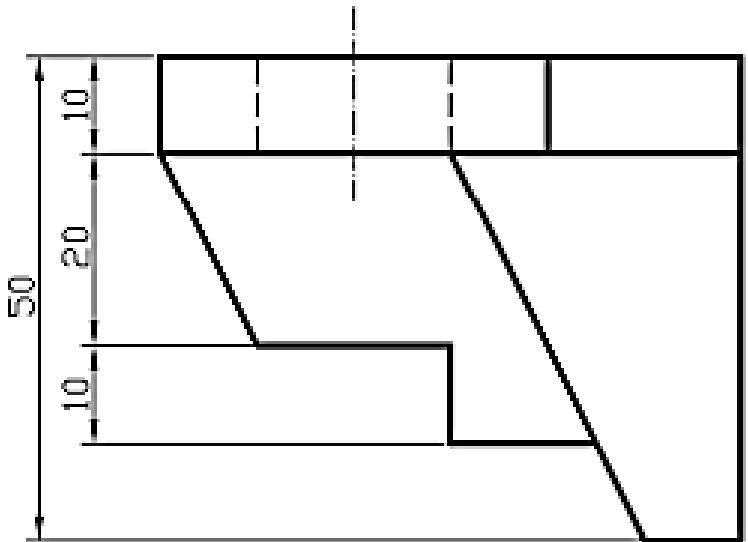

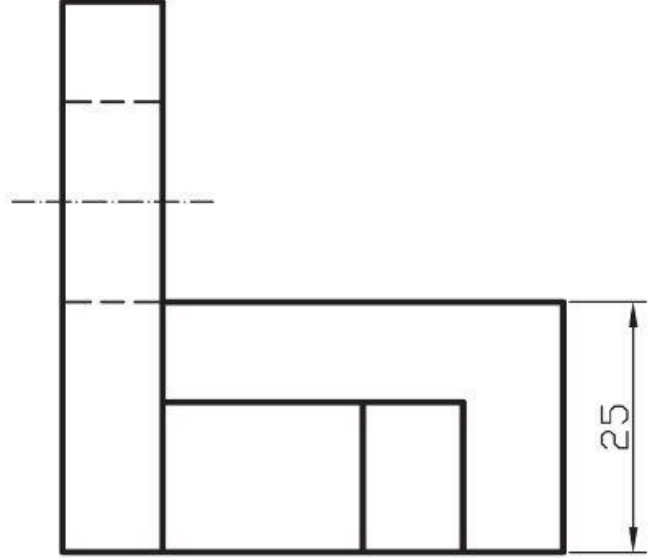
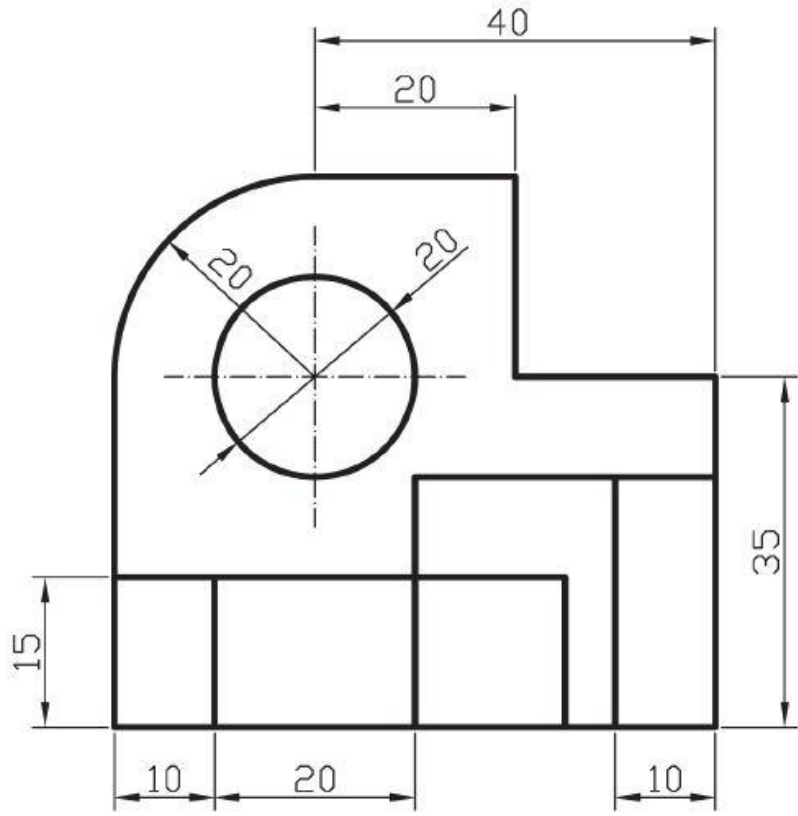
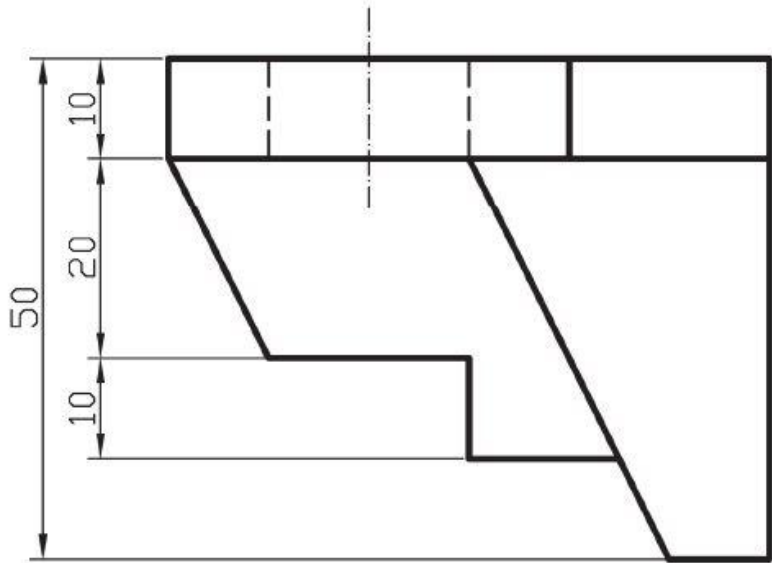

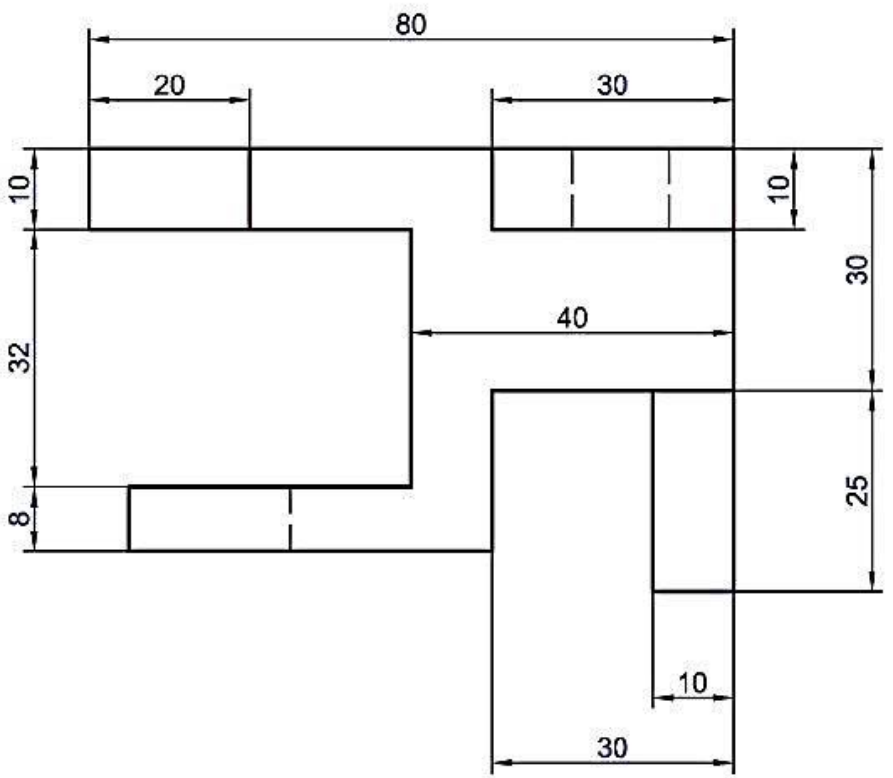
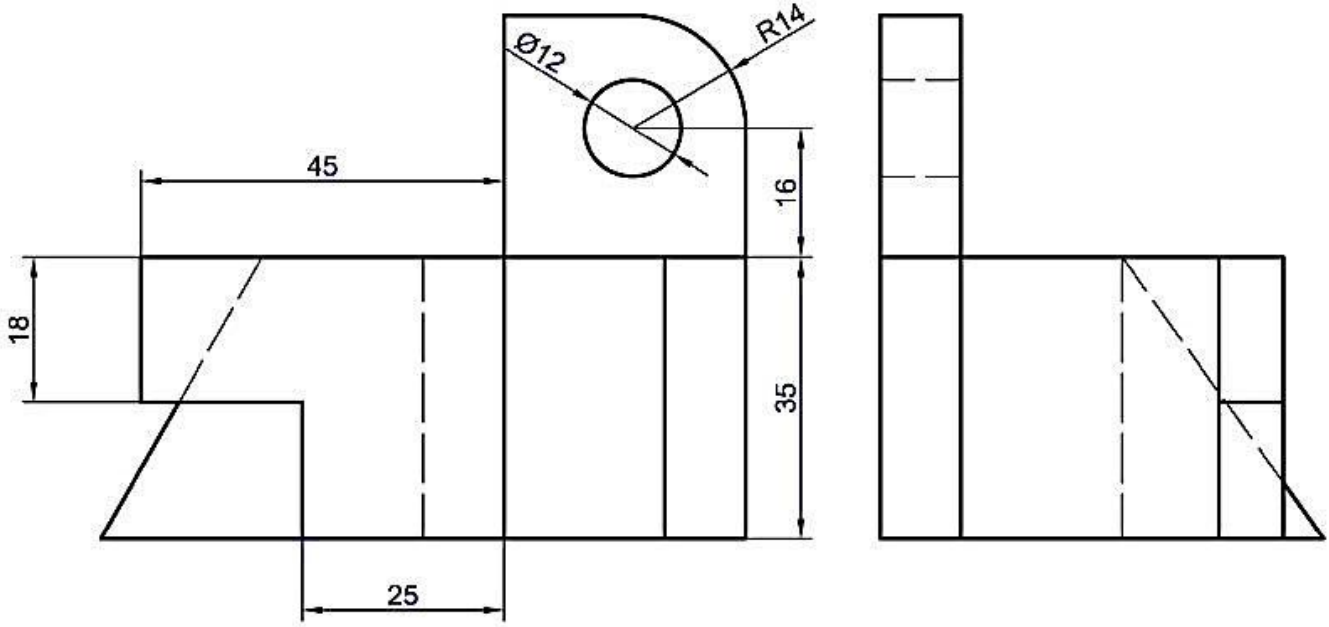

Convert the following multi-view drawings to isometric and oblique drawings
*Measurements are in millimeters. Draw one item in one sheet and double the measurements.

a. To isometric:

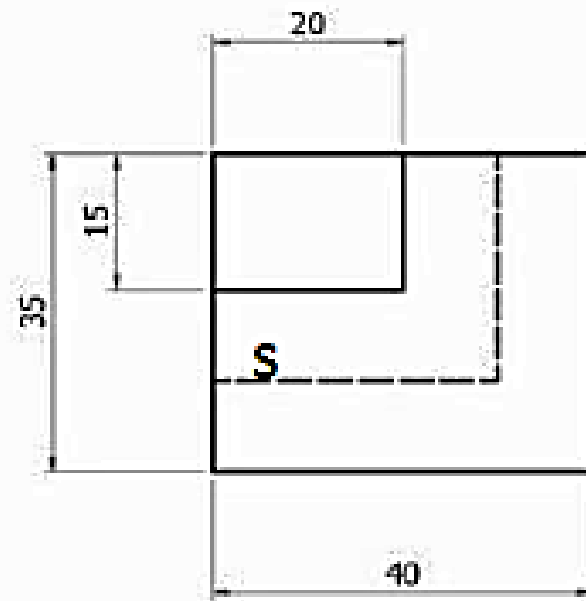
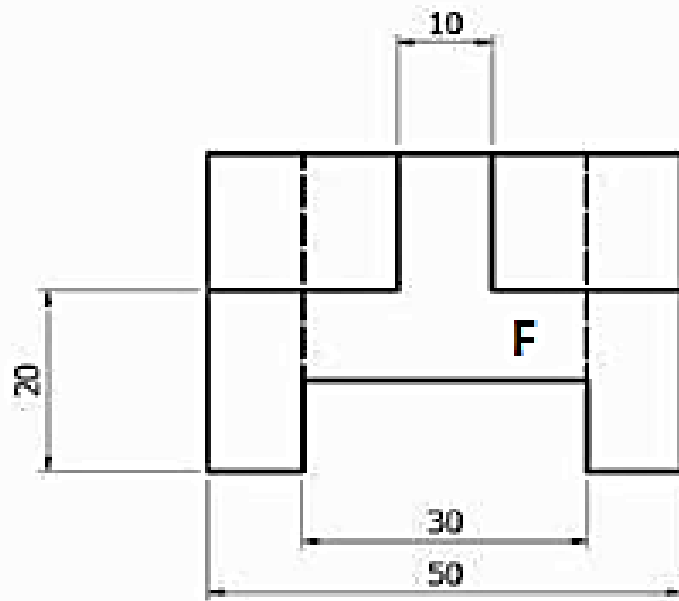
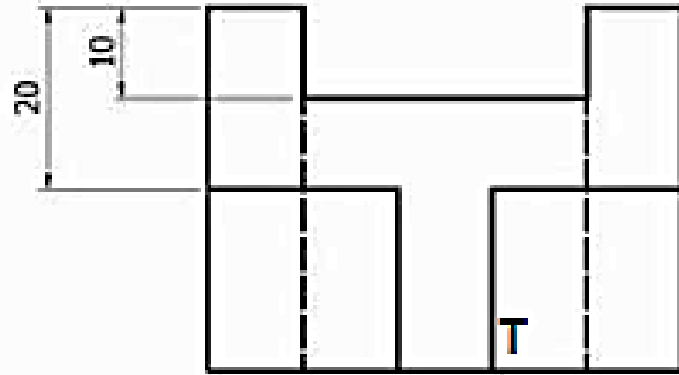

a. To isometric:

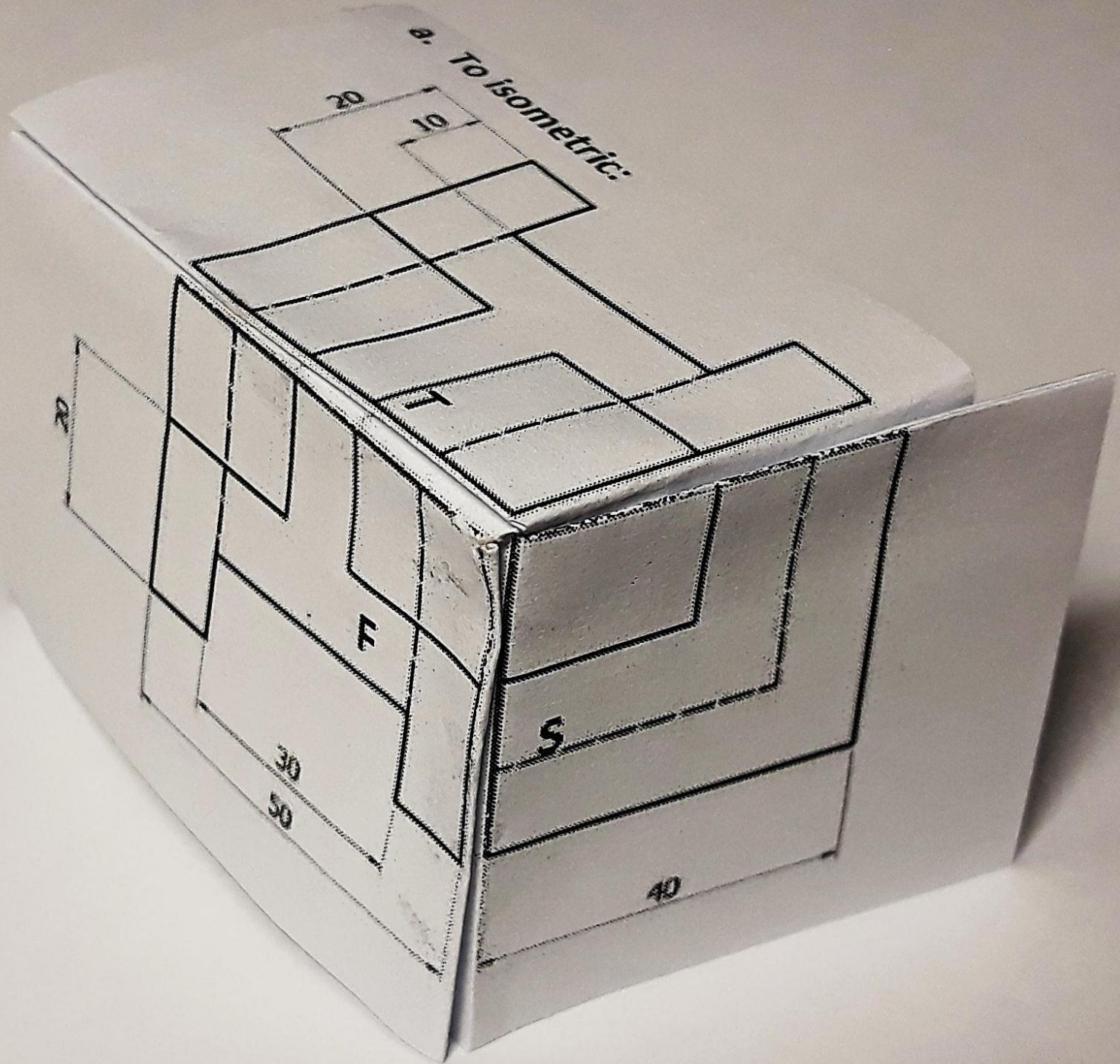

referencias

- <http://www.educacionplastica.net/MenuIso.htm>
- <http://www.educacionplastica.net/MenuDie.htm>